



Metallized Conductive Products

- Fabric-Over-Foam
- Conductive Foam
- Fabric
- Tape

We practice environmental protection



Laird
TECHNOLOGIES®



Laird Technologies manufactures a wide range of EMI shielding materials and related products for the computer, telecommunications, aerospace, defense, general electronics, medical equipment and automotive industries. These include beryllium copper fingerstock, knitted wire mesh, conductive elastomers in extruded profiles, molded shapes and form-in-place gaskets, fabric-over-foam and a full range PC board shields, shielded windows, custom metal stampings and ventilation panels. Also offered are microwave and EMI microwave absorber products. In addition, the company provides EMC and product engineering and testing services.

This catalog is designed to provide technical specifications and material characteristics for all categories of metallized fabric and foam products available from Laird Technologies. These products include:

Fabric-Over-Foam

Profile and Input/Output (I/O) EMI shielding gaskets available in UL94 V0 and HB flame retardant material—ideal for applications requiring low compression force.

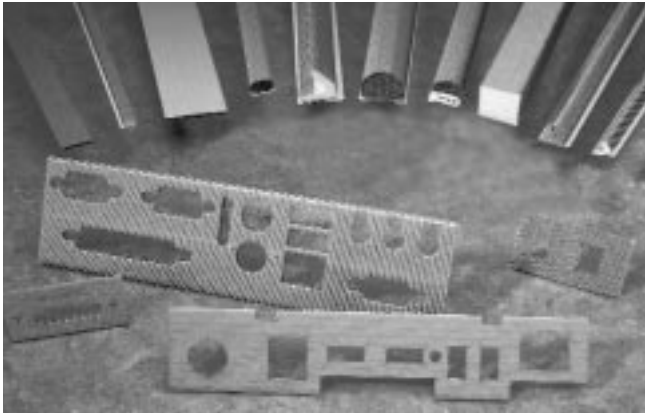

Conductive Foam

Conductive foam gaskets provide the enhanced EMI shielding effectiveness required by the microprocessor speeds of today's computer and telecommunications equipment.

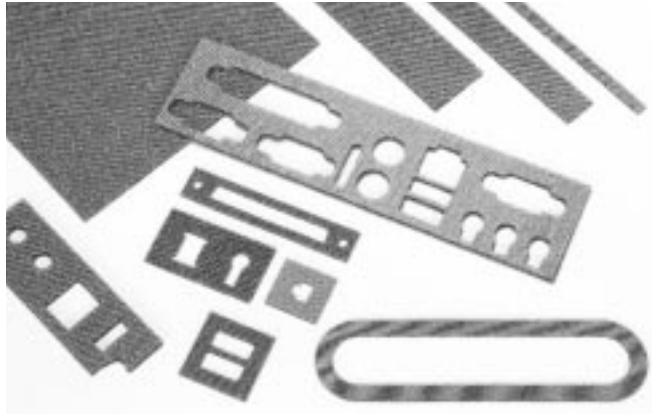

Conductive Fabric

Metallized fabric combines highly conductive metals with lightweight fabric to meet a diverse range of EMI/RFI shielding requirements.

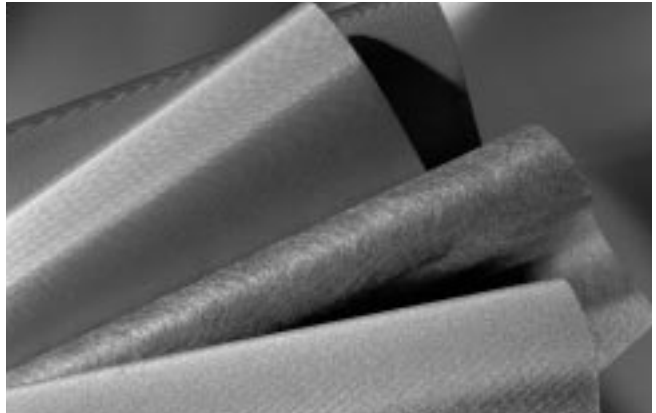

Conductive Tape

Conductive shielding tape offers excellent conductivity, conformability and durability in a thin, lightweight and flexible shielding design.

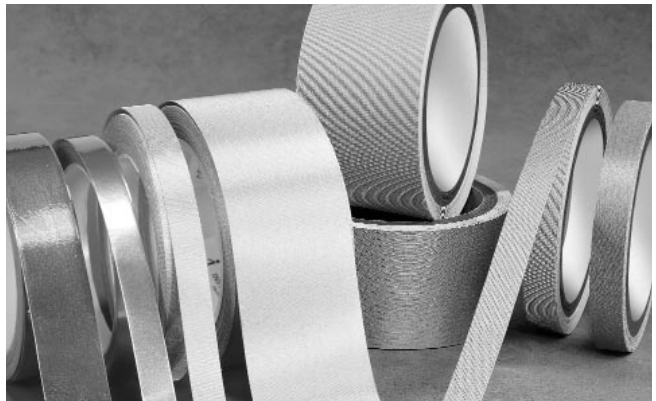

All dimensions shown are in inches (millimeters) unless otherwise specified.



Table of Contents



Part Number Cross Reference 3-6



Fabric-Over-Foam Shielding Gaskets

Introduction	7
Profile and I/O Construction Options	8
Profile Selection Guide	
D-Shaped	9
Rectangle Shaped	9-10
D-Shaped Clip	11
Rectangle Shaped Clip	11
C-Fold Shaped	11
Square Shaped	11
P-Shaped	11
D-Shaped Metal Dart	12
Knife Shaped	12
J-Shaped	12
Bell Shaped	12
B-Shaped Clip	12
C-Fold With Clip	12
Custom Bell Shaped	13
Double D-Shaped	13
Double Rectangle Shaped	13
L-Shaped	13
Oval Shaped	13
Round Shaped	13
T-Shaped	13
How To Order	18



Fabric-Over-Foam I/O Gaskets

Introduction	14
I/O Gaskets Selection Guide	
D-Sub Connector Series	15
USB Port 4 Pin Connector	15
I/O Connector	15
IEEE 1394 I/O 4 Pin Connector	16
SCSI + 50 Pin Connector	16
RJ-45 Connector	16
SCSI + 68 Pin Connector	17
USB Port Connector	17
How To Order	18



Conductive Foam

Introduction	19
Profile Selection Guide	
Rectangle Shaped	20
I/O Gaskets Selection Guide	
D-Sub Connector Series	21
USB Port 4 Pin Connector	21
USB Port Connector	22
I/O Connector	22
Backplanes – Large Conductive Foam Gaskets Selection Guide	23
How To Order	24



Conductive Fabric 25-26



Conductive Tape

Conductive ElectroTape	27
Conductive ElectroMask Tape	28
High-Flex® Conductive Fabric Shielding Tapes	29
How To Order (High-Flex Tapes)	29





Part Number Cross Reference

Part #	Product	Page
Conductive Fabric		
3027-106	Cu Polyester Nonwoven	25
3027-217	Ni/Cu Polyester Nonwoven	25
3027-235	Ni/Cu Polyester Nonwoven UL94 VTM-0	25
3035-213	Ni/Cu Polyester Taffeta	25
3035-216	Ni/Cu Polyester Taffeta UL94 V0	25
3050-113	Cu Nylon Ripstop	25
3050-226	Ni/Cu Nylon Ripstop	25
3050-517	Ni/Cu Nylon Ripstop UL94 V0	25
3055-121	Cu Polyester Ripstop	25
3055-233	Ni/Cu Polyester Ripstop	25
3070-500	Ni/Cu Polyester Mesh	25

Fabric-Over-Foam

4016	D-Shaped Metal Dart	12
4023	D-Shaped Metal Dart	12
4027	D-Shaped Metal Dart	12
4031	D-Shaped Metal Dart	12
4032	C-Fold with Clip	12
4033	D-Shaped Clip	11
4037	B-Shaped Clip	12
4038	D-Shaped Clip	11
4039	D-Shaped Clip	11
4040	D-Shaped Clip	11
4041	D-Shaped Clip	11
4042	Rectangle Shaped	10
4043	D-Shaped Clip	11
4046	Square Shaped	11
4047	Rectangle Shaped	10
4048	Square Shaped	11
4049	Square Shaped	11
4051	Rectangle Shaped	9
4051-EE	IEEE 1394 I/O 4 Pin Connector	16
4052	D-Shaped	9
4053	D-Shaped	9
4054	J-Shaped	12
4055	Rectangle Shaped	10
4056	Rectangle Shaped	9
4057	Rectangle Shaped	10
4058	Rectangle Shaped	9
4060	D-Shaped	9
4062	Rectangle Shaped	10
4064	Rectangle Shaped	10
4065	Rectangle Shaped	10
4066	Rectangle Shaped	10
4070	Rectangle Shaped	10
4071	Rectangle Shaped	9
4078	D-Shaped	9
4079	Rectangle Shaped	9
4080	Rectangle Shaped	9
4080-FK	USB Port Connector	17
4081	Rectangle Shaped	10

Part #	Product	Page
Fabric-Over-Foam (continued)		
4082	Rectangle Shaped	10
4083	Rectangle Shaped	10
4084	Square Shaped	11
4085	D-Shaped Clip	11
4086	Rectangle Shaped	9
4087	Rectangle Shaped	10
4088	Rectangle Shaped	9
4089	Square Shaped	11
4090	D-Shaped	9
4091	Rectangle Shaped	9
4094	Rectangle Shaped	9
4096	Rectangle Shaped	9
4097	Knife Shaped	12
4098	Rectangle Shaped	10
4100	Rectangle Shaped	10
4105	D-Shaped	9
4106	Knife Shaped	12
4110	D-Shaped Clip	11
4111	D-Shaped Clip	11
4112	D-Shaped	9
4113	Rectangle Shaped	10
4114	Rectangle Shaped	10
4115	Rectangle Shaped	10
4117	J-Shaped	12
4120	D-Shaped	9
4121	D-Shaped Clip	11
4123	D-Shaped	9
4126	Rectangle Shaped	10
4131	Bell Shaped	12
4133	Rectangle Shaped	10
4134	D-Shaped	9
4136	Rectangle Shaped	10
4142	Rectangle Shaped	10
4143	Rectangle Shaped	9
4148	Rectangle Shaped	9
4150	P-Shaped	11
4154	C-Fold Shaped	11
4157	Rectangle Shaped	9
4158	Rectangle Shaped	10
4160	Rectangle Shaped	9
4161	Rectangle Shaped	9
4163	Rectangle Shaped	9
4164	Rectangle Shaped	9
4164-EE	D-Sub Connector	15
4164-FE	SCSI + 50 Pin Connector	16
4164-FF	SCSI + 68 Pin Connector	17
4164-FH	RJ-45 Connector	16
4164-FW	D-Sub Connector	15
4164-FY	D-Sub Connector	15
4164-FZ	D-Sub Connector	15
4164-GA	D-Sub Connector	15

All dimensions shown are in inches (millimeters) unless otherwise specified.



Part Number Cross Reference

Part #	Product	Page
Fabric-Over-Foam (continued)		
4168	C-Fold Shaped	11
4169	Rectangle Shaped	9
4170	Rectangle Shaped	9
4171	Rectangle Shaped	9
4172	Rectangle Shaped	10
4173	Rectangle Shaped	10
4176	Rectangle Shaped	10
4179	Rectangle Shaped	9
4181	D-Shaped	9
4182	Rectangle Shaped	10
4183	Oval Shaped	13
4184	D-Shape Shaped	9
4186	Rectangle Shaped	9
4189	Knife Shaped	12
4192	Rectangle Shaped	10
4194	Rectangle Shaped	10
4198	C-Fold Shaped	11
4199	Rectangle Shaped	9
4200	Rectangle Shaped	10
4201	Round Shaped	13
4202	D-Shaped	9
4203	Rectangle Shaped	10
4204	Square Shaped	11
4205	Knife Shaped	12
4206	Square Shaped	11
4208	Rectangle Shaped	9
4209	Rectangle Shaped	10
4210	Rectangle Shaped	10
4211	Rectangle Shaped	10
4212	Square Shaped	11
4215	Rectangle Shaped	9
4216	Rectangle Shaped	10
4219	Rectangle Shaped	9
4219-EB	USB Port 4 Pin Connector	15
4220	Rectangle Shaped	9
4222	Rectangle Shaped	10
4223	Rectangle Shaped	9
4224	Rectangle Shaped	10
4225	Rectangle Shaped	9
4226	Rectangle Shaped	10
4227	Rectangle Shaped	10
4228	D-Shaped	9
4231	Rectangle Shaped	9
4231-EE	I/O Connector	15
4233	Rectangle Shaped	10
4235	Rectangle Shaped	9
4237	Rectangle Shaped	10
4238	Rectangle Shaped	10
4239	Rectangle Shaped	10
4240	D-Shaped	9
4241	Rectangle Shaped	10

Part #	Product	Page
Fabric-Over-Foam (continued)		
4242	D-Shaped	9
4243	C-Fold Shaped	11
4244	C-Fold Shaped	11
4245	Rectangle Shaped	9
4246	Rectangle Shaped	9
4247	Rectangle Shaped	10
4248	Rectangle Shaped	10
4249	Rectangle Shaped	10
4250	Rectangle Shaped	10
4251	Rectangle Shaped	10
4252	Rectangle Shaped	10
4253	Rectangle Shaped	10
4254	Rectangle Shaped	10
4255	Rectangle Shaped	10
4256	Rectangle Shaped	10
4257	Rectangle Shaped	10
4258	Rectangle Shaped	10
4259	Rectangle Shaped	9
4260	Rectangle Shaped	10
4262	Rectangle Shaped	10
4263	Rectangle Shaped	10
4264	Rectangle Shaped	10
4268	Rectangle Shaped	9
4269	D-Shaped	9
4270	Rectangle Shaped	9
4272	Rectangle Shaped	10
4273	Rectangle Shaped	9
4281	Rectangle Shaped	10
4283	D-Shaped	9
4285	Rectangle Shaped	10
4286	Rectangle Shaped	10
4293	Double Rectangle Shaped	13
4295	D-Shaped	9
4297	Rectangle Shaped	9
4299	Double D-Shaped	13
4300	Rectangle Shaped	9
4302	Rectangle Shaped	9
4315	Rectangle Shaped	10
4320	D-Shaped	9
4325	Rectangle Shaped	10
4330	Rectangle Shaped	10
4339	Rectangle Shaped	10
4349	T-Shaped	13
4355	Rectangle Shaped	10
4356	D-Shaped	9
4358	D-Shaped	9
4359	Rectangle Shaped	10
4360	Rectangle Shaped	10
4361	Rectangle Shaped	10
4363	Rectangle Shaped	9
4365	Rectangle Shaped	10

LT_KA_2003_01_MCP_E_15M · ©2003 Laird Technologies

All dimensions shown are in inches (millimeters) unless otherwise specified.





Part Number Cross Reference

Part #	Product	Page
Fabric-Over-Foam (continued)		
4368	D-Shaped	9
4370	Rectangle Shaped	10
4372	Round Shaped	13
4375	D-Shaped	9
4376	Rectangle Shaped	10
4379	Bell Shaped	12
4387	Bell Shaped	12
4389	Rectangle Shaped	10
4391	Rectangle Shaped	10
4392	Rectangle Shaped	10
4394	Rectangle Shaped	9
4404	Rectangle Shaped	9
4408	Rectangle Shaped	9
4410	Rectangle Shaped	9
4413	Rectangle Shaped Clip	11
4430	Rectangle Shaped	9
4455	Rectangle Shaped	9
4469	L-Shaped	13
4478	Oval Shaped	13
4499	Rectangle Shaped	10
4500	Rectangle Shaped	9
4501	Rectangle Shaped	9
4502	J-Shaped	12
4512	Rectangle Shaped	9
4513	Rectangle Shaped	10
4516	Rectangle Shaped	10
4517	Square Shaped	11
4518	Rectangle Shaped	9
4520	Square Shaped	11
4522	Square Shaped	11
4524	Rectangle Shaped	10
4525	Rectangle Shaped	10
4528	Rectangle Shaped	10
4529	C-Fold Shaped	11
4531	Rectangle Shaped	10
4532	Rectangle Shaped	9
4533	Rectangle Shaped	10
4534	L-Shaped	13
4536	Rectangle Shaped	10
4537	P-Shaped	11
4541	D-Shaped	9
4542	D-Shaped	9
4548	D-Shaped	9
4568	Rectangle Shaped	10
4569	Rectangle Shaped	9
4570	Rectangle Shaped	9
4571	Rectangle Shaped	10
4572	Rectangle Shaped	9
4573	Rectangle Shaped	9
4575	Rectangle Shaped	10
4576	Custom Bell Shaped	13

Part #	Product	Page
Fabric-Over-Foam (continued)		
4577	Rectangle Shaped	9
4579	Rectangle Shaped	9
4581	D-Shaped	9
4582	Rectangle Shaped	10
4583	Rectangle Shaped	10
4584	D-Shaped	9
4591	Rectangle Shaped	9
4593	C-Fold Shaped	11
4594	Rectangle Shaped	10
4596	Rectangle Shaped	9
4597	Rectangle Shaped	9
4599	Rectangle Shaped	9
4600	C-Fold Shaped	11
4601	Rectangle Shaped	10
4602	Rectangle Shaped	9
4603	Rectangle Shaped	10
4606	Rectangle Shaped	9
4607	D-Shaped	9
4608	C-Fold Shaped	11
4609	D-Shaped	9
4610	Rectangle Shaped	10
4612	Rectangle Shaped	10
4615	Rectangle Shaped	10
4619	Rectangle Shaped	10
4626	Rectangle Shaped	9
4628	Rectangle Shaped	9
4629	Rectangle Shaped	9
4630	Bell Shaped	12
4632	Rectangle Shaped	10
4633	Bell Shaped	12
4649	Rectangle Shaped	10
4650	Rectangle Shaped	10
4674	Rectangle Shaped	10
4675	Rectangle Shaped	10
4677	Rectangle Shaped	9
4679	Rectangle Shaped	9
4686	Rectangle Shaped	10
4687	Rectangle Shaped	10
4688	Rectangle Shaped	9
4691	C-Fold Shaped	11
4692	D-Shaped	9
4693	Rectangle Shaped	10
4694	Rectangle Shaped	10
4695	Square Shaped	11
4696	C-Fold Shaped	11
4697	C-Fold Shaped	11
4698	Rectangle Shaped	10
4699	P-Shaped	11
4701	Rectangle Shaped	10
4702	Rectangle Shaped	10
4703	C-Fold Shaped	11

All dimensions shown are in inches (millimeters) unless otherwise specified.



Part Number Cross Reference

Part #	Product	Page
Fabric-Over-Foam (continued)		
4704	Rectangle Shaped	10
4705	Rectangle Shaped	10
4740	Rectangle Shaped	10
4741	Rectangle Shaped	10
4742	D-Shaped	9
4743	D-Shaped	9
4744	Rectangle Shaped	10
4786	Rectangle Shaped	10
4787	D-Shaped	9
4788	Rectangle Shaped	10
4789	D-Shaped	9
4791	Rectangle Shaped	10
4792	P-Shaped	11
4795	Rectangle Shaped	10
4796	Knife Shaped	12
4797	Knife Shaped	12
4798	Rectangle Shaped	10
4799	Rectangle Shaped	10
4801	Rectangle Shaped	10
4850	Rectangle Shaped	9
4900	Rectangle Shaped	10
4902	Rectangle Shaped	10
4903	Rectangle Shaped	10
4906	D-Shaped	9
4907	Rectangle Shaped	9
4912	D-Shaped	9
4913	Rectangle Shaped Clip	11
4914	Rectangle Shaped	10

Conductive Foam

5010	Backplane Profile	23
5015	Rectangle Shaped	20
5023	Rectangle Shaped	20
5037-EB	USB Port Connector	22
5044	Backplane Profile	23
5068-EA	USB Port 4 Pin Connector	21
5076	Rectangle Shaped	20
5078	Rectangle Shaped	20
5092	Rectangle Shaped	20
5100	Rectangle Shaped	20
5104	Rectangle Shaped	20
5125	Rectangle Shaped	20
5151	Backplane Profile	23
5152	Backplane Profile	23
5157	Rectangle Shaped	20
5164-EA	D-Sub Connector	21
5164-EE	D-Sub Connector	21
5164-EF	D-Sub Connector	21
5167	Rectangle Shaped	20
5168	Rectangle Shaped	20
5169	Rectangle Shaped	20

Part #	Product	Page
Conductive Foam (continued)		
5174	Rectangle Shaped	20
5176	Rectangle Shaped	20
5191	Rectangle Shaped	20
5213	Backplane Profile	23
5214	Rectangle Shaped	20
5219	Rectangle Shaped	20
5220	Rectangle Shaped	20
5221	Rectangle Shaped	20
5233	Rectangle Shaped	20
5239-EG	I/O Connector	22
5241	Backplane Profile	23
5242	Backplane Profile	23
5248	Backplane Profile	23
5249	Backplane Profile	23
5261	Rectangle Shaped	20
5262	Rectangle Shaped	20
5264	Backplane Profile	23
5268	Backplane Profile	23
5269	Backplane Profile	23
5286	Rectangle Shaped	20
5308	Rectangle Shaped	20
5997	Rectangle Shaped	20
5999	Backplane Profile	23

Conductive Tape

8271-xxxx-39	Copper Foil Tape	27
8271-xxxx-76	Tin Plated Copper Foil Tape	27
8277-xxxx-77	Aluminium Foil Tape	27
8277-xxxx-39	Copper Foil Tape	27
8277-xxxx-76	Tin Plated Copper Foil Tape	27
8274-xxxx-39	Copper Foil Tape	28
8274-xxxx-76	Tin Plated Copper Foil Tape	28





Metallized Fabric-Over-Foam Shielding Gaskets

Laird Technologies is a fully integrated manufacturer of profile and Input/Output (I/O) EMI shielding gaskets. The metallized Fabric-Over-Foam product line has been expanded greatly due to our committed efforts in new product development.

This catalog has been developed to provide helpful information to design engineers on our expanded offering. In this section you can find out about the benefits of Fabric-Over-Foam Gaskets, material options and review an extensive list of standard profile and I/O sizes and configurations.

Laird Technologies specializes in the quick turnaround of custom shapes and sizes of EMI shielding gaskets.

If you don't find exactly what you need, our engineers will help you design the right solution to your shielding problem.

A sampling of standard profiles are shown; custom configurations and sizes can be designed to meet your specific requirements. Profiles are shown in ascending order by height (starting on page 9).



Benefits of Fabric-Over-Foam Gaskets

- Shielding effectiveness of >100dB (MIL-STD 285 mod.) (see figure 1).
- Extremely low compression forces, ranging from 5-10 lbs./ft., allows use of lighter materials and less fastening and hinge hardware (see figure 2).
- Low Surface Resistivity of < 0.07 ohms/square provides improved conductivity (ASTM F390).
- Wide range of flame retardant gaskets available (UL recognized per UL94 V0 or UL94 HB).
- Abrasion resistant metallized fabrics show virtually no degradation in shielding performance after 1,000,000 cycles (ASTM 3880).
- Urethane & Thermoplastic Elastomer (TPE) cores provide low compression set of 5-20 % (ASTM D3574) ensuring long-term reliability of gasket performance.
- Service temperatures from -40 °F to 158 °F (-40°C to 70°C) (ASTM D746).
- Available in Nickel/Copper (Ni/Cu) and Tin/Copper (Sn/Cu) to ensure galvanic compatibility with a wide variety of host materials. Both versions display no significant performance degradation after environmental exposure per the Accelerated Aging Test (ASTM 845).
- Prototype samples can be provided within 24 hours utilizing laser technology, CAD/CAM equipment, and customer supplied drawings in DWG®, DXF®, IGS, PDF®, and BMP file formats.
- Profile and I/O gaskets are available with a variety of PSA tapes, including Easy Peel® with extra wide release liner, which facilitates quick assembly.
- Profile gaskets can be cut to specified lengths, kiss-cut on release liner, or mitered to form frame configurations.

Figure 1

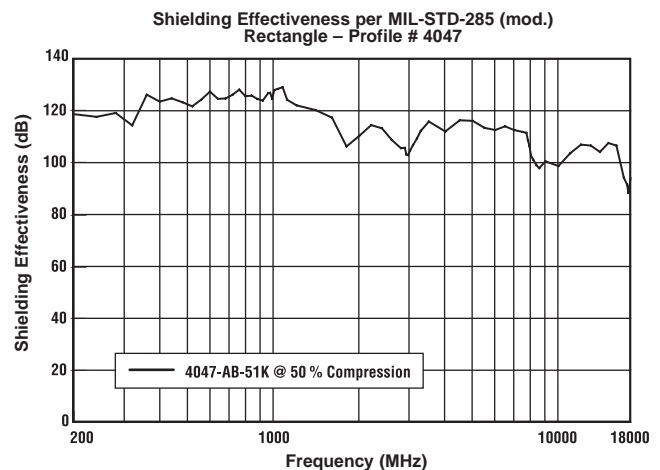

LT_KA_2003_01_MCP_E_15M · ©2003 Laird Technologies



Profile & I/O Construction Options

Fabric*

Fabric Types	Metal Coating	Conductivity (ASTM F390)	Application	Benefits
Ripstop	Ni/Cu, Sn/Cu	< 0.07 ohms/square	I/O or Profile Gaskets	Complex Shapes, Flame Retardant, Shear Resistance
Taffeta	Ni/Cu	< 0.07 ohms/square	Profile Gaskets	Complex Shapes, Flame Retardant
Knit Mesh	Ni/Cu	< 0.07 ohms/square	I/O Gaskets	Low Cost, Flame Retardant

Pressure Sensitive Adhesive*

Pressure Sensitive Adhesive	180° Peel Strength on Stainless Steel (ASTM 3330)	Temperature Resistance (3M™ Internal Test)	Application	Benefits
3M™ 9485 or equivalent	75 oz/in (82 N/100 mm)	Short Term: 450 °F (232 °C) Long Term: 300 °F (149 °C)	High Tack, Shear Resistant	High Peel Strength and Temperature Resistant
Nitto D5052 or equivalent	87 oz / in (95 N/100 mm)	Short Term: 311 °F (155 °C) Long Term: 240 °F (160 °C)	High Tack, Shear Resistant	High Cohesive Strength, High Peel Strength and Temperature Resistant
3M™ 950 or equivalent	75 oz/in (82 N/100 mm)	Short Term: 250 °F (121 °C) Long Term: 180 °F (82 °C)	High Tack	High Peel Strength

Other Pressure Sensitive Adhesives can be provided. Contact Engineering to discuss requirements.

Foam*

Foam Types	Compression Set (ASTM D 3574)	Color	Application	Benefits
Urethane	5 to 10 %	Black or Grey	I/O or Profile Gaskets	Flame Retardant, Low Compression Gasket, Complex Shapes
Thermoplastic Elastomer (TPE)	< 20 %	Yellow or White	Profile Gaskets	Complex Shapes, Flame Retardant

The recommended operating compression for Fabric-Over-Foam EMI Gaskets will vary depending on the shape and size of the particular gasket.

Typically, D-Shaped, Rectangular Shaped, and Square Shaped Fabric-Over-Foam EMI Gaskets should be compressed between 30 % and 50 % of the foam height.

Similarly, C-Shaped Fabric-Over-Foam EMI Gaskets should typically be compressed between 50 % and 75 % of the gasket height.

* Certain combinations of materials may not be available for all Profiles or I/Os. Please consult the Engineering Department at Laird Technologies when unsure.

Figure 2

Force Displacement Resistance Comparing Different Foams Urethane Foam & Thermoplastic Elastomer (TPE Foam)

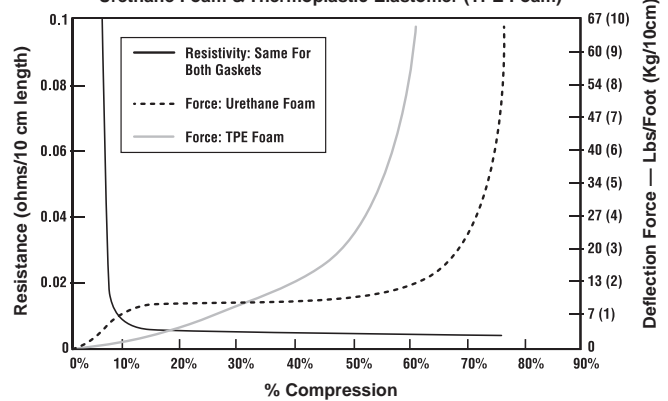

Diverse Assembly Options

Multiple attachment options provide a variety of ways to install critical EMI products. Pressure Sensitive Adhesive (PSA) has been complemented with the Easy Peel® release liner, rigid clip, and pop rivet configurations. These mechanical attachment options enable you to take advantage of existing tooling on doors and enclosures as well as offer alternate attachment methods to better meet design requirements.

Profile Gasket Tolerances

Profile	Tolerance Inches (Millimeters)
Height & Width	± .020 (0.5)
Length Inches (Millimeters)	Tolerance Inches (Millimeters)
1 to 6 (25.4 – 152.4)	± .030 (0.8)
6 to 11 (152.4 – 279.4)	± .050 (1.3)
11 to 48 (279.4 – 1219.2)	± .100 (2.5)
48 to 70 (1219.2 – 1778.0)	± .187 (4.7)
70 to 96 (1778.0 – 2438.4)	± .250 (6.4)

For parts shorter than 1 inch (25.4mm), or longer than 96" (2438.4mm), please consult Engineering for tolerances. See back cover for contact information.

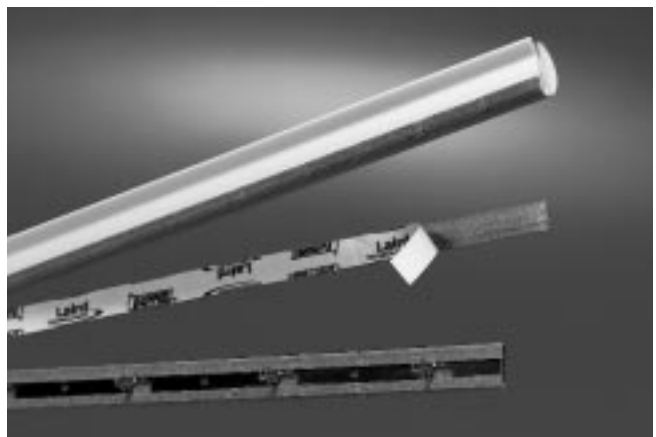

All dimensions shown are in inches (millimeters) unless otherwise specified.



Fabric-Over-Foam Profile Selection Guide

D-Shaped

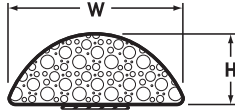

Profile Number	inches (mm) H	inches (mm) W
4584	0.040 (1.0)	0.150 (3.8)
4320	0.050 (1.3)	0.140 (3.6)
4541	0.050 (1.3)	0.250 (6.4)
4358	0.060 (1.5)	0.100 (2.5)
4184	0.060 (1.5)	0.150 (3.8)
4548	0.060 (1.5)	0.250 (6.4)
4356	0.070 (1.8)	0.180 (4.6)
4052	0.080 (2.0)	0.080 (2.0)
4283	0.080 (2.0)	0.160 (4.1)
4181	0.080 (2.0)	0.394 (10.0)
4053	0.090 (2.3)	0.090 (2.3)
4912	0.090 (2.3)	0.150 (3.8)
4375	0.094 (2.4)	0.200 (5.1)
4240	0.100 (2.5)	0.300 (7.6)
4742	0.120 (3.0)	0.150 (3.8)
4202	0.120 (3.0)	0.250 (6.4)
4078	0.120 (3.0)	0.360 (9.1)

Profile Number	inches (mm) H	inches (mm) W
4090	0.125 (3.2)	0.090 (2.3)
4906	0.130 (3.3)	0.188 (4.8)
4692	0.140 (3.6)	0.250 (6.4)
4228	0.150 (3.8)	0.150 (3.8)
4123	0.150 (3.8)	0.354 (9.0)
4112	0.158 (4.0)	0.433 (11.0)
4120	0.160 (4.1)	0.240 (6.1)
4295	0.170 (4.3)	0.250 (6.4)
4609	0.180 (4.6)	0.400 (10.2)
4787	0.200 (5.1)	0.250 (6.4)
4134	0.200 (5.1)	0.390 (9.9)
4607	0.200 (5.1)	0.480 (12.2)
4242	0.250 (6.4)	0.250 (6.4)
4542	0.250 (6.4)	0.290 (7.4)
4789	0.250 (6.4)	0.375 (9.5)
4368	0.299 (7.6)	0.272 (6.9)
4105	0.375 (9.5)	0.500 (12.7)
4060	0.500 (12.7)	0.500 (12.7)
4269	0.562 (14.3)	0.709 (18.0)
4743	0.787 (20.0)	0.580 (14.7)
4581	0.984 (25.0)	0.745 (18.9)

Rectangle Shaped

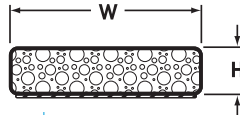

Profile Number	inches (mm) H	inches (mm) W
4570	0.015 (0.4)	0.200 (5.1)
4577	0.015 (0.4)	0.276 (7.0)
4572	0.015 (0.4)	0.394 (10.0)
4300	0.017 (0.4)	0.826 (21.0)
4058	0.020 (0.5)	0.157 (4.0)
4569	0.020 (0.5)	0.196 (5.0)
4500	0.020 (0.5)	1.217 (30.9)
4501	0.020 (0.5)	1.970 (50.0)
4850	0.030 (0.8)	0.900 (22.9)
4245	0.040 (1.0)	0.120 (3.0)
4223	0.040 (1.0)	0.157 (4.0)
4220	0.040 (1.0)	0.200 (5.1)
4404	0.040 (1.0)	0.240 (6.1)
4215	0.040 (1.0)	0.275 (7.0)
4208	0.040 (1.0)	0.395 (10.0)
4219	0.040 (1.0)	0.510 (13.0)
4259	0.040 (1.0)	0.600 (15.2)
4677	0.040 (1.0)	0.709 (18.0)
4532	0.040 (1.0)	0.750 (19.1)
4597	0.040 (1.0)	0.900 (22.9)
4297	0.040 (1.0)	1.000 (25.4)
4363	0.040 (1.0)	1.126 (28.6)
4179	0.040 (1.0)	1.431 (36.3)
4512	0.040 (1.0)	1.640 (41.7)
4270	0.040 (1.0)	1.770 (45.0)
4573	0.040 (1.0)	1.840 (46.7)
4394	0.040 (1.0)	3.300 (83.8)
4246	0.050 (1.3)	0.090 (2.3)
4088	0.050 (1.3)	0.220 (5.6)
4086	0.055 (1.4)	0.850 (21.6)
4273	0.060 (1.5)	0.130 (3.3)
4056	0.060 (1.5)	0.200 (5.1)
4157	0.060 (1.5)	0.280 (7.1)
4629	0.060 (1.5)	0.390 (9.9)
4051	0.060 (1.5)	0.500 (12.7)

Profile Number	inches (mm) H	inches (mm) W
4455	0.060 (1.5)	0.551 (14.0)
4430	0.060 (1.5)	0.591 (15.0)
4626	0.060 (1.5)	0.610 (15.5)
4606	0.060 (1.5)	0.620 (15.7)
4579	0.060 (1.5)	0.650 (16.5)
4164	0.060 (1.5)	0.750 (19.1)
4170	0.060 (1.5)	0.866 (22.0)
4225	0.060 (1.5)	0.900 (22.9)
4080	0.060 (1.5)	1.000 (25.4)
4599	0.060 (1.8)	1.063 (27.0)
4518	0.060 (1.5)	1.235 (31.4)
4079	0.060 (1.5)	1.330 (33.8)
4161	0.060 (1.5)	1.370 (34.8)
4163	0.060 (1.5)	1.400 (35.6)
4591	0.060 (1.5)	1.455 (37.0)
4091	0.060 (1.5)	1.525 (38.7)
4628	0.060 (1.5)	1.580 (40.1)
4231	0.060 (1.5)	1.615 (41.0)
4679	0.060 (1.5)	1.690 (42.9)
4408	0.060 (1.5)	1.740 (44.2)
4148	0.060 (1.5)	1.870 (47.6)
4169	0.060 (1.5)	1.900 (48.3)
4160	0.060 (1.5)	2.310 (58.7)
4235	0.060 (1.5)	2.520 (64.0)
4596	0.060 (1.5)	3.091 (78.5)
4907	0.060 (1.5)	3.780 (96.0)
4071	0.062 (1.6)	0.300 (7.6)
4171	0.062 (1.6)	0.870 (22.1)
4143	0.062 (1.6)	2.000 (50.8)
4268	0.070 (1.8)	0.160 (4.1)
4302	0.070 (1.8)	0.550 (13.9)
4199	0.070 (1.8)	0.650 (16.5)
4410	0.070 (1.8)	1.063 (27.0)
4688	0.079 (2.0)	0.118 (3.0)
4094	0.080 (2.0)	0.160 (4.1)
4186	0.080 (2.0)	0.200 (5.1)
4602	0.080 (2.0)	0.236 (6.0)
4096	0.080 (2.0)	0.275 (7.0)

continued

All dimensions shown are in inches (millimeters) unless otherwise specified.



Fabric-Over-Foam Profile Selection Guide

Rectangle Shaped (continued)

Profile Number	inches (mm) H	inches (mm) W
4650	0.080 (2.0)	0.300 (7.6)
4601	0.080 (2.0)	0.315 (8.0)
4182	0.080 (2.0)	0.400 (10.2)
4675	0.080 (2.0)	0.535 (13.6)
4359	0.080 (2.0)	0.710 (18.0)
4571	0.080 (2.0)	0.787 (20.0)
4200	0.080 (2.0)	0.830 (21.1)
4361	0.080 (2.0)	0.900 (22.9)
4325	0.080 (2.0)	0.984 (25.0)
4194	0.080 (2.0)	1.130 (28.7)
4389	0.080 (2.0)	1.259 (32.0)
4315	0.080 (2.0)	1.345 (34.2)
4531	0.080 (2.0)	1.550 (39.4)
4263	0.080 (2.0)	1.620 (41.1)
4262	0.080 (2.0)	1.736 (44.1)
4260	0.080 (2.0)	1.842 (46.8)
4355	0.080 (2.0)	5.340 (135.6)
4339	0.090 (2.3)	0.200 (5.1)
4903	0.090 (2.3)	0.535 (13.6)
4248	0.090 (2.3)	1.060 (26.9)
4254	0.090 (2.3)	1.370 (34.8)
4255	0.090 (2.3)	1.655 (42.0)
4256	0.090 (2.3)	1.700 (43.2)
4801	0.100 (2.5)	0.265 (6.7)
4082	0.100 (2.5)	0.375 (9.5)
4612	0.100 (2.5)	0.500 (12.7)
4133	0.100 (2.5)	0.350 (8.9)
4285	0.100 (2.5)	1.330 (33.8)
4582	0.100 (2.5)	1.500 (38.1)
4330	0.100 (2.5)	1.630 (41.4)
4083	0.110 (2.8)	0.240 (6.1)
4042	0.118 (3.0)	0.125 (3.2)
4619	0.118 (3.0)	0.197 (5.0)
4272	0.118 (3.0)	0.315 (8.0)
4583	0.118 (3.0)	0.787 (20.0)
4209	0.120 (3.0)	0.155 (3.9)
4210	0.120 (3.0)	0.355 (9.0)
4286	0.120 (3.0)	0.390 (9.9)
4264	0.120 (3.0)	0.750 (19.1)
4536	0.120 (3.0)	1.551 (39.4)
4126	0.120 (3.0)	1.720 (43.7)
4788	0.125 (3.2)	0.250 (6.4)
4694	0.125 (3.2)	0.500 (12.7)
4065	0.125 (3.2)	0.600 (15.2)
4247	0.125 (3.2)	0.700 (17.8)
4376	0.125 (3.2)	0.720 (18.3)
4064	0.125 (3.2)	1.000 (25.4)
4603	0.125 (3.2)	1.125 (28.6)
4066	0.125 (3.2)	1.250 (31.8)
4158	0.125 (3.2)	1.400 (35.6)
4239	0.125 (3.2)	1.615 (41.0)
4238	0.125 (3.2)	1.850 (47.0)
4693	0.130 (3.3)	0.190 (4.8)
4062	0.130 (3.3)	0.380 (9.7)
4694	0.130 (3.3)	0.500 (12.7)
4632	0.130 (3.3)	1.630 (41.4)
4575	0.130 (3.3)	2.000 (50.8)
4615	0.138 (3.5)	0.197 (5.0)
4594	0.140 (3.6)	0.350 (8.9)
4525	0.140 (3.6)	0.512 (13.0)
4203	0.150 (3.8)	0.100 (2.5)
4047	0.150 (3.8)	0.500 (12.7)
4533	0.156 (4.0)	0.630 (16.0)
4799	0.156 (4.0)	0.650 (16.5)
4914	0.156 (4.0)	0.709 (18.0)
4499	0.157 (4.0)	0.197 (5.0)
4741	0.157 (4.0)	0.256 (6.5)

Profile Number	inches (mm) H	inches (mm) W
4055	0.157 (4.0)	0.315 (8.0)
4516	0.157 (4.0)	0.354 (9.0)
4791	0.157 (4.0)	0.394 (10.0)
4098	0.157 (4.0)	0.591 (15.0)
4704	0.158 (4.0)	0.236 (6.0)
4241	0.160 (4.1)	0.200 (5.1)
4253	0.160 (4.1)	0.280 (7.1)
4114	0.160 (4.1)	0.430 (10.9)
4115	0.160 (4.1)	0.590 (15.0)
4249	0.160 (4.1)	0.790 (20.1)
4257	0.160 (4.1)	0.880 (22.4)
4252	0.160 (4.1)	0.985 (25.0)
4250	0.160 (4.1)	1.375 (34.9)
4251	0.160 (4.1)	1.700 (43.2)
4142	0.177 (4.5)	0.354 (9.0)
4370	0.180 (4.6)	2.000 (50.8)
4902	0.190 (4.8)	0.310 (7.9)
4258	0.190 (4.8)	1.625 (41.3)
4698	0.195 (5.0)	0.130 (3.3)
4211	0.195 (5.0)	0.395 (10.0)
4674	0.197 (5.0)	0.512 (13.0)
4360	0.197 (5.0)	0.591 (15.0)
4281	0.200 (5.1)	3.900 (99.1)
4365	0.216 (5.5)	0.394 (10.0)
4100	0.216 (5.5)	0.500 (12.7)
4786	0.217 (5.5)	0.394 (10.0)
4528	0.217 (5.5)	0.709 (18.0)
4087	0.225 (5.7)	0.218 (5.5)
4701	0.250 (6.4)	0.375 (9.5)
4795	0.250 (6.4)	0.500 (12.7)
4798	0.250 (6.4)	0.600 (15.2)
4226	0.250 (6.4)	0.750 (19.1)
4224	0.250 (6.4)	1.000 (25.4)
4705	0.256 (6.5)	0.236 (6.0)
4740	0.256 (6.5)	0.394 (10.0)
4649	0.275 (7.0)	0.394 (10.0)
4568	0.275 (7.0)	0.511 (13.0)
4113	0.276 (7.0)	0.433 (11.0)
4227	0.283 (7.2)	1.180 (30.0)
4222	0.295 (7.5)	0.591 (15.0)
4237	0.295 (7.5)	1.500 (38.1)
4057	0.315 (8.0)	0.157 (4.0)
4687	0.315 (8.0)	0.236 (6.0)
4216	0.315 (8.0)	0.395 (10.0)
4610	0.335 (8.5)	0.394 (10.0)
4702	0.375 (9.5)	0.250 (6.4)
4081	0.375 (9.5)	0.500 (12.7)
4070	0.375 (9.5)	0.750 (19.1)
4192	0.375 (9.5)	1.000 (25.4)
4176	0.394 (10.0)	0.787 (20.0)
4513	0.413 (10.5)	0.394 (10.0)
4173	0.413 (10.5)	0.512 (13.0)
4524	0.452 (11.5)	0.472 (12.0)
4391	0.500 (13.0)	0.984 (25.0)
4172	0.591 (15.0)	0.394 (10.0)
4233	0.600 (15.2)	1.000 (25.4)
4136	0.670 (17.0)	0.590 (15.0)
4900	0.700 (17.8)	0.500 (12.7)
4686	0.710 (18.0)	0.390 (9.9)
4744	0.787 (20.0)	0.580 (14.7)
4392	0.790 (20.1)	0.350 (8.9)



LT_KA_2003_01_MCP_E_15M · ©2003 Laird Technologies

All dimensions shown are in inches (millimeters) unless otherwise specified.



Fabric-Over-Foam Profile Selection Guide

D-Shaped Clip

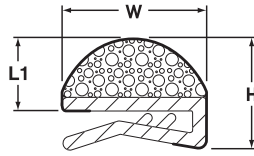

Profile Number	inches (mm) H	inches (mm) W	inches (mm) L1
4110	0.203 (5.2)	0.250 (6.4)	0.125 (3.2)
4111	0.215 (5.5)	0.250 (6.4)	0.165 (4.1)
4039	0.300 (7.7)	0.480 (12.2)	0.190 (4.8)
4033	0.350 (8.9)	0.480 (12.2)	0.240 (6.1)
4121	0.358 (9.1)	0.250 (6.4)	0.280 (7.1)
4040	0.410 (10.4)	0.480 (12.2)	0.300 (7.6)
4038	0.430 (10.9)	0.490 (12.4)	0.310 (7.9)
4043	0.430 (10.9)	0.490 (12.4)	0.310 (7.9)
4085	0.430 (10.9)	0.490 (12.4)	0.310 (7.9)
4041	0.518 (13.2)	0.480 (12.2)	0.458 (11.6)

Rectangle Shaped Clip

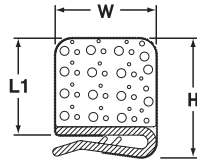

Profile Number	inches (mm) H	inches (mm) W	inches (mm) L1
4913	0.440 (11.2)	0.375 (9.5)	0.360 (9.1)
4413	0.485 (12.3)	0.390 (9.9)	0.405 (10.3)

C-Fold Shaped

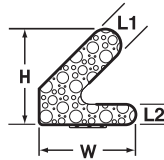

Profile Number	inches (mm) H	inches (mm) W	inches (mm) L1	inches (mm) L2
4593	0.250 (6.4)	0.280 (7.1)	0.125 (3.2)	0.060 (1.5)
4168	0.315 (8.0)	0.315 (8.0)	0.080 (2.0)	0.080 (2.0)
4198	0.385 (9.8)	0.420 (10.7)	0.115 (2.9)	0.060 (1.5)
4154	0.395 (10)	0.430 (10.9)	0.125 (3.2)	0.060 (1.5)
4696	0.395 (10.0)	0.430 (10.9)	0.125 (3.2)	0.080 (2.0)

Profile Number	inches (mm) H	inches (mm) W	inches (mm) L1	inches (mm) L2
4243	0.400 (10.2)	0.430 (10.9)	0.125 (3.2)	0.040 (1.0)
4600	0.415 (10.5)	0.450 (11.4)	0.135 (3.4)	0.650 (1.7)
4529	0.465 (11.8)	0.420 (10.7)	0.115 (2.9)	0.060 (1.5)
4691	0.470 (11.9)	0.487 (12.4)	0.110 (2.8)	0.110 (2.8)
4608	0.675 (17.1)	0.580 (14.7)	0.155 (3.9)	0.140 (3.6)
4697	0.675 (17.1)	0.590 (15.0)	0.165 (4.2)	0.156 (4.0)
4244	0.675 (17.1)	0.600 (15.2)	0.165 (4.2)	0.165 (4.2)
4703	0.940 (23.9)	0.550 (14.0)	0.155 (3.9)	0.170 (4.3)

Square Shaped

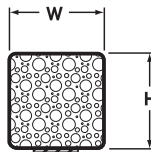

Profile Number	inches (mm) H	inches (mm) W
4520	0.080 (2.0)	0.080 (2.0)
4046	0.118 (3.0)	0.118 (3.0)
4522	0.157 (4.0)	0.157 (4.0)
4212	0.195 (5.0)	0.195 (5.0)
4048	0.236 (6.0)	0.236 (6.0)
4049	0.250 (6.4)	0.250 (6.4)
4695	0.375 (9.5)	0.375 (9.5)
4206	0.395 (10.0)	0.395 (10.0)
4084	0.500 (12.7)	0.500 (12.7)
4204	0.670 (17.0)	0.670 (17.0)
4517	0.750 (19.1)	0.750 (19.1)
4089	0.790 (19.7)	0.790 (19.7)

P-Shaped

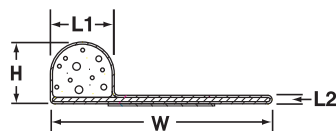

Profile Number	inches (mm) H	inches (mm) W	inches (mm) L1	inches (mm) L2
4150	0.120 (3.1)	0.520 (13.2)	0.242 (6.1)	0.020 (.50)
4699	0.145 (3.7)	0.520 (13.2)	0.150 (3.8)	0.020 (.50)
4792	0.200 (5.1)	0.480 (12.2)	0.170 (4.3)	0.090 (2.3)
4537	0.374 (9.5)	0.887 (22.5)	0.500 (13.0)	0.051 (1.0)

All dimensions shown are in inches (millimeters) unless otherwise specified.



Fabric-Over-Foam Profile Selection Guide

D-Shaped Metal Dart

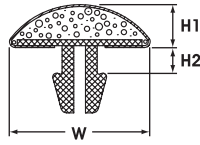

Profile Number	inches (mm) H1	inches (mm) H2	inches (mm) W
4027	0.110 (2.8)	0.067 (1.7)	0.360 (9.1)
4023	0.110 (2.8)	0.107 (2.7)	0.360 (9.1)
4016	0.140 (3.6)	0.040 (1.0)	0.360 (9.1)
4031	0.160 (4.1)	0.040 (1.0)	0.360 (9.1)

Knife Shaped

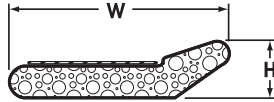

Profile Number	inches (mm) H	inches (mm) W
4797	0.106 (2.7)	0.445 (11.3)
4097	0.110 (2.8)	0.320 (8.1)
4796	0.110 (2.8)	0.450 (11.4)
4205	0.250 (6.4)	0.750 (19.1)
4106	0.312 (7.9)	0.707 (18.0)
4189	0.350 (8.9)	0.750 (19.1)

J-Shaped

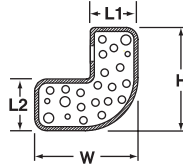

Profile Number	inches (mm) H	inches (mm) W	inches (mm) L1	inches (mm) L2
4117	0.130 (3.3)	0.130 (3.3)	0.060 (1.5)	0.065 (1.7)
4054	0.209 (5.3)	0.130 (3.3)	0.071 (1.8)	0.063 (1.6)
4502	0.400 (10.2)	0.300 (7.6)	0.175 (4.4)	0.140 (3.6)

Bell Shaped

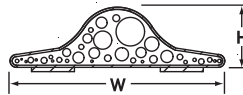

Profile Number	inches (mm) H	inches (mm) W
4630	0.070 (1.8)	0.180 (4.6)
4379	0.070 (1.8)	0.560 (14.2)
4387	0.080 (2.0)	0.680 (17.3)
4633	0.100 (2.5)	0.300 (7.6)
4131	0.140 (3.6)	0.500 (12.7)

B-Shaped Clip

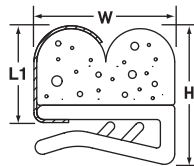

Profile Number	inches (mm) H	inches (mm) W	inches (mm) L1
4037	0.218 (5.5)	0.245 (6.2)	0.168 (4.3)

C-Fold with Clip

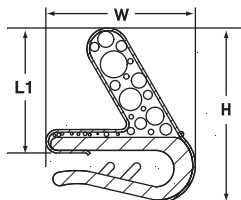

Profile Number	inches (mm) H	inches (mm) W	inches (mm) L1
4032	0.335 (8.5)	0.287 (7.3)	0.240 (6.1)

LT_KA_2003_01_MCP_E_15M · ©2003 Laird Technologies

All dimensions shown are in inches (millimeters) unless otherwise specified.



Fabric-Over-Foam Profile Selection Guide

Custom Bell Shaped

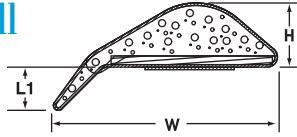

Profile Number	inches (mm) H	inches (mm) W	inches (mm) L1
4576	0.335 (8.5)	0.287 (7.3)	0.240 (6.1)

Double D Shaped

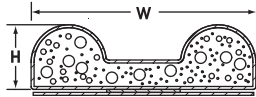

Profile Number	inches (mm) H	inches (mm) W
4299	0.110 (2.8)	0.380 (9.7)

Double Rectangle Shaped



Profile Number	inches (mm) H	inches (mm) W
4293	0.080 (2.0)	1.830 (46.5)

L-Shaped

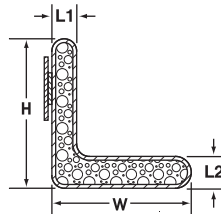

Profile Number	inches (mm) H	inches (mm) W	inches (mm) L1	inches (mm) L2
4469	0.216 (5.5)	0.354 (9.0)	.138 (3.5)	.118 (3.0)
4534	0.591 (15)	0.550 (14)	.098 (2.5)	.126 (3.2)

Oval Shaped

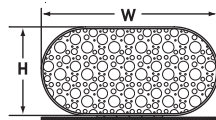

Profile Number	inches (mm) H	inches (mm) W
4478	0.138 (3.5)	0.197 (5.0)
4183	0.250 (6.4)	0.500 (12.7)

Round Shaped

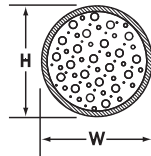

Profile Number	inches (mm) H	inches (mm) W
4201	0.100 (2.5)	0.100 (2.5)
4372	0.125 (3.2)	0.125 (3.2)

T-Shaped

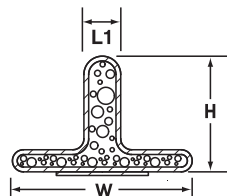

Profile Number	inches (mm) H	inches (mm) W	inches (mm) L1
4349	0.157 (4.0)	0.244 (6.2)	0.050 (1.3)

All dimensions shown are in inches (millimeters) unless otherwise specified.



Fabric-Over-Foam I/O Gasket Selection Guide

The following pages have examples of standard I/O gaskets used in computer and telecommunication applications. If you have different requirements, our Engineering Department will design your gasket to the specifications that you supply. We will design your I/O from a fully detailed print, drawing file, or the actual panel to which the gasket is to be applied.

I/O Gasket Tolerances

Height tolerance: $\pm .020"$ (± 0.5 mm)

Width tolerance: $\pm .020"$ (± 0.5 mm)

Length tolerance: $\pm .020"$ (± 0.5 mm)

Cutout tolerance: $\pm .020"$ (± 0.5 mm)

If different tolerances are required, please consult Engineering. See back cover for contact information.

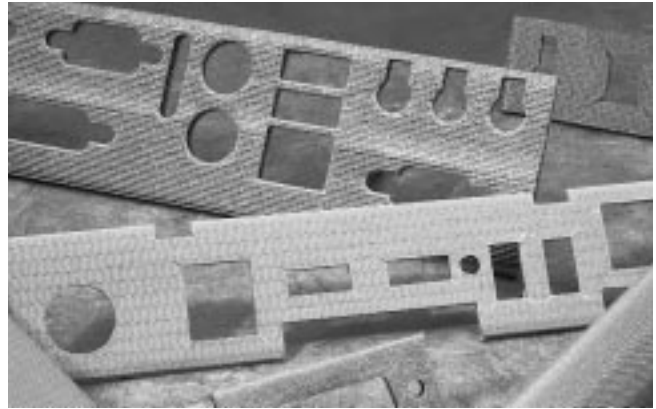

Basic I/O Gasket Design

- 1 Space between required cutouts should match or exceed 0.060" (1.5 mm).
- 2 Distance from the edge of a cutout should be at least 0.060" (1.5 mm) from the edge of the gasket. In most cases, a slot can be used in place of a hole that is positioned too close to the gasket edge.
- 3 All cutouts and locations are designed to the customer's specification.
- 4 Pressure-Sensitive Adhesive (PSA) and Extended Release Liner (ERL) can be applied in parallel with the long edge of the gasket.

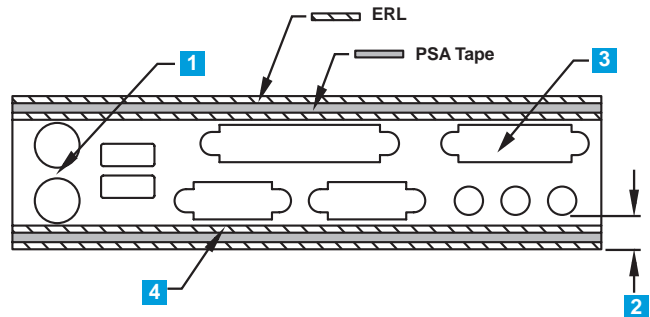

The recommended operating compression for Fabric-Over-Foam EMI gaskets will vary depending on the shape and size of the particular gasket. Typically, I/O gaskets should be compressed between 30 % and 50 % of the foam height.



D-Sub Connector Series

Part No.	#Pins	A	B	C	D	E	Usage
4164-EE	9	1.320 (33.5)	.984 (25.0)	.650 (16.5)	.155 (4.0)	.310 (8.0)	Serial, Mouse, Com, Port
4164-FW	11, 15	1.640 (41.7)	1.310 (33.3)	.971 (24.7)	.155 (3.9)	.310 (7.9)	VGA, Game, Multi-media, Serial Port
4164-FY	25	2.204 (56.0)	1.865 (47.4)	1.500 (38.1)	.155 (3.9)	.310 (7.9)	Parallel, Serial, Scanner, Printers
4164-FZ	37	2.859 (72.6)	2.535 (64.4)	2.200 (55.9)	.155 (3.9)	.310 (7.9)	Serial Port
4164-GA	50	2.750 (69.9)	2.406 (61.1)	2.064 (52.4)	.211 (5.4)	.422 (10.7)	Serial Port

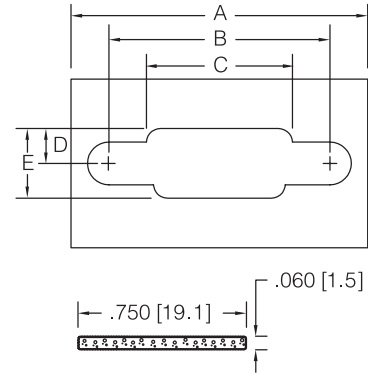

USB Port 4 Pin Connector, Part Number 4219-EB

Usage: Multi-use, hot plug-and-play

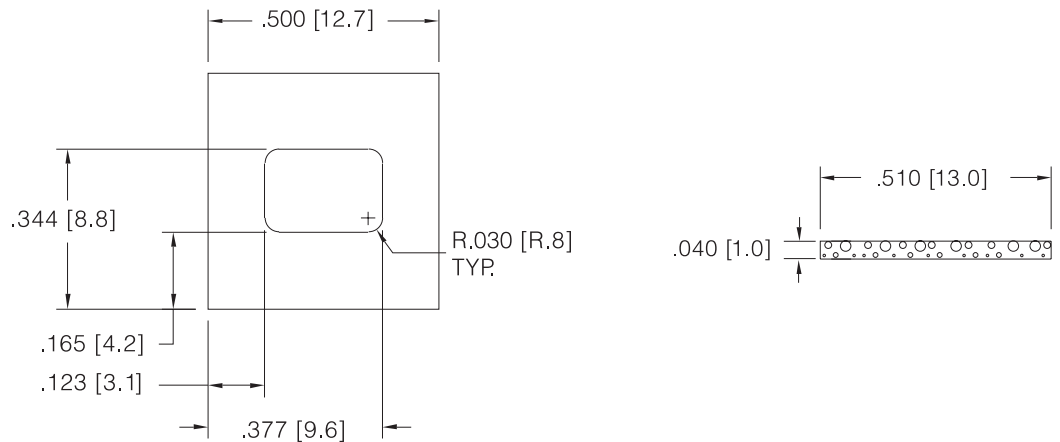

I/O Connector, Part Number 4231-EE

Usage: Standard PC Motherboard/Main Board (MB) I/O Shield

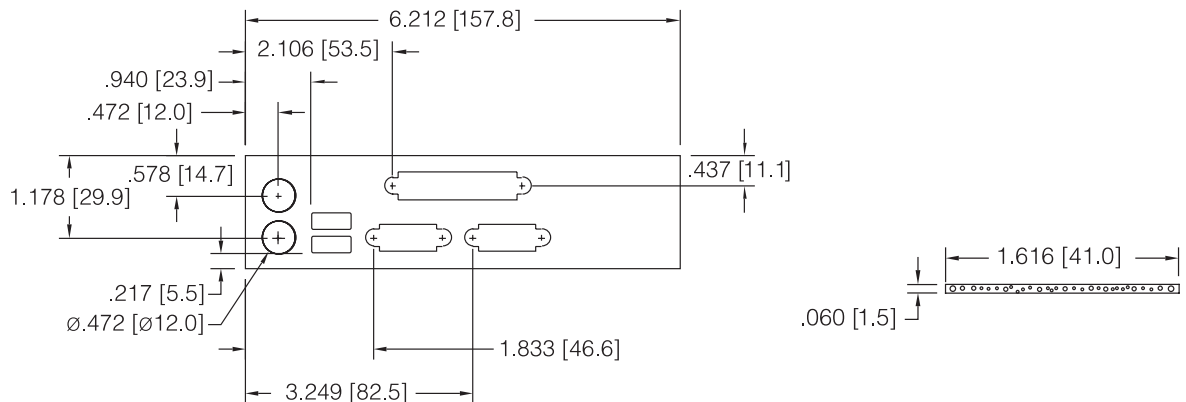

All dimensions shown are in inches (millimeters) unless otherwise specified.



IEEE 1394 I/O 4 Pin Connector, Part Number 4051-EE

Usage: Plug-and-Play Serial Port (Digital Cameras, Printers, Keyboards, Mouse)

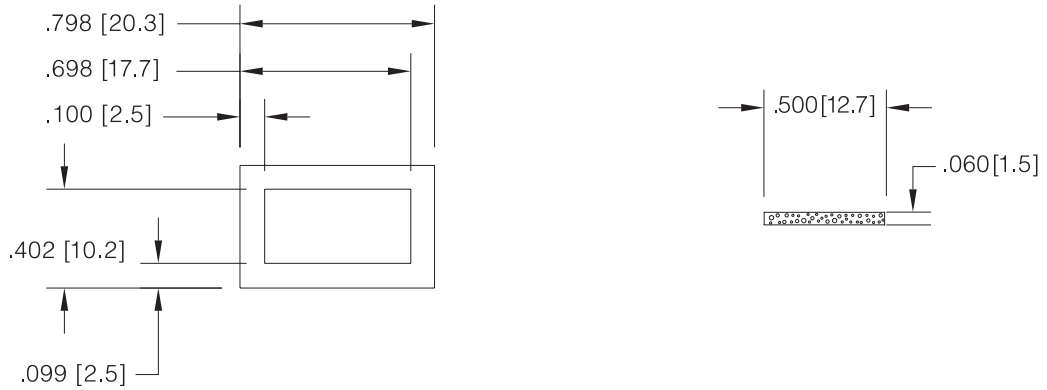

SCSI + 50 Pin Connector, Part Number 4164-FE

Usage: Peripheral, Hard Disk, CD-ROM

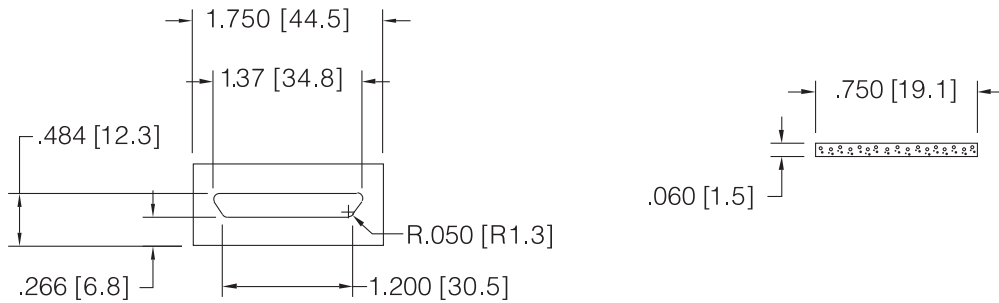

RJ-45 Connector, Part Number 4164-FH

Usage: Telecom, Ethernet Networking

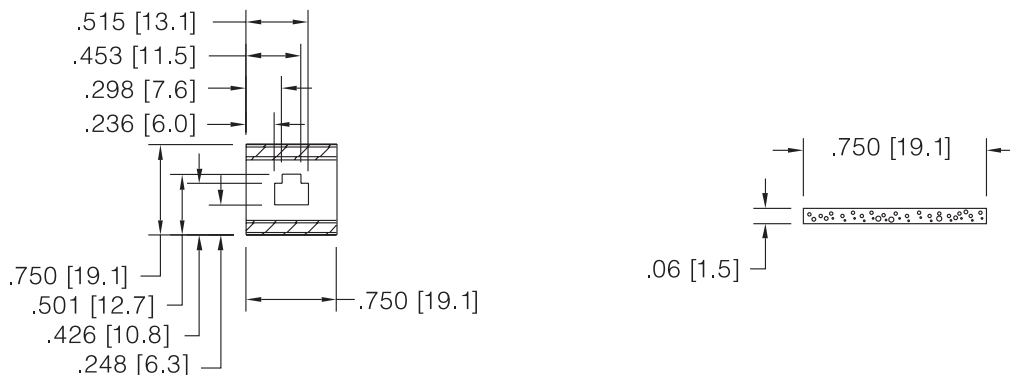

LT_KA_2003_01_MCP_E_15M · ©2003 Laird Technologies

All dimensions shown are in inches (millimeters) unless otherwise specified.



Fabric-Over-Foam I/O Gasket Selection Guide

SCSI + 68 Pin Connector, Part Number 4164-FF

Usage: Peripheral, External Hard Drive

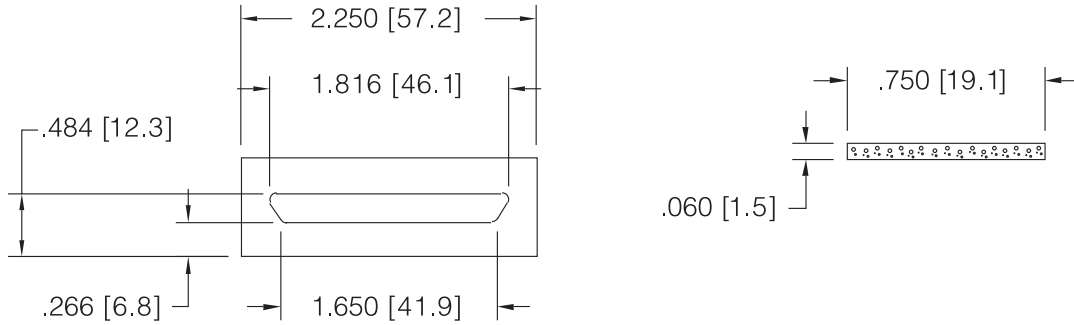

USB Port Connector, Part Number 4080-FK

Usage: Peripheral Port

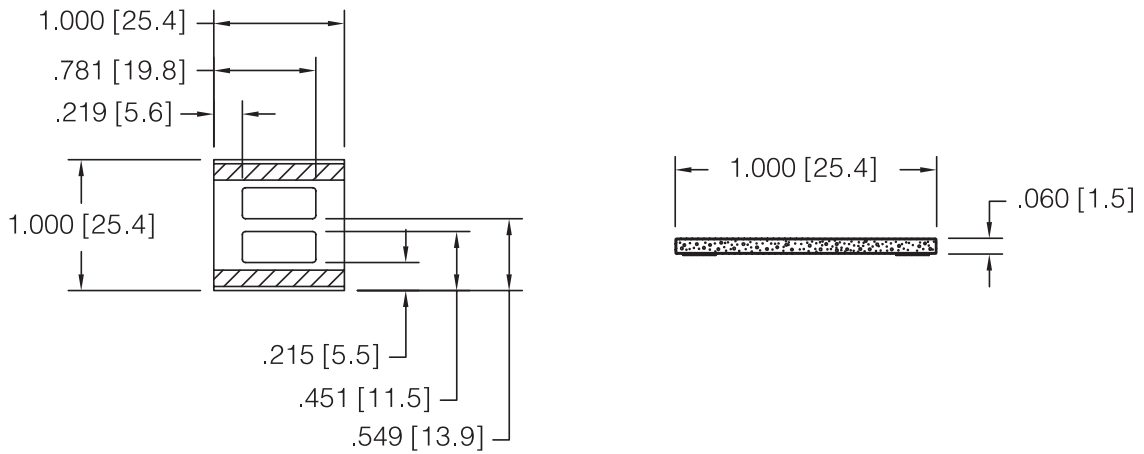

All dimensions shown are in inches (millimeters) unless otherwise specified.



Fabric-Over-Foam Profile and I/O Ordering Information

Part Number Example:

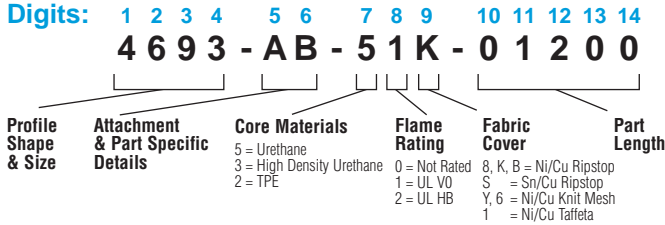

* Certain combinations of materials may not be available for all Profiles or I/Os. Please consult the Engineering Department at Laird Technologies when unsure.

See back cover for contact information.

Digits 1 through 4

Designate profile number. Select profile or I/O and sizes from pages 9-13 (Profile) or 15-17 (I/O).

Digits 5 through 6

Designate part-specific attributes of the product including cutouts, notches, tape width, tape position and a variety of other customized details. A B is the default and usually designates Pressure Sensitive Adhesive centered on base. These digits will be supplied by Laird Technologies' Engineering personnel.

Digits 7 through 9

Designate the core materials, flame rating and fabric cover combinations. Select these from the recommended list in the table below. Other foam and fabric combinations are available, please consult Laird Technologies' Engineering Department. See page 8 for additional material performance data.

Digits 10 through 14

Designate the part length in inches to two decimal places (i.e., In the above example, the "01200" denotes a 12.00 inch (304.8 mm) long gasket).

Construction Options

Part Number Suffix Digits (Digits 7,8,9)	Foam Core	Gasket UL94 Flame Rating	Metallized Fabric Type	Benefits	Target Gasket
51K	Urethane	UL94 V0	Ni/Cu Ripstop	Flame Retardant, High Shear Resistant, Low Compression Set	I/O or Profile
51Y	Urethane	UL94 V0	Ni/Cu Knit Mesh	Flame Retardant, Low Compression Set	I/O
51S	Urethane	UL94 V0	Sn/Cu Ripstop	Flame Retardant, Shear Resistant, Low Compression Set	I/O or Profile
31K	High Density Urethane	UL94 V0	Ni/Cu Ripstop	Flame Retardant, Shear Resistant, Low Compression Set	Complex Shapes (C-Fold, T-Shaped, etc.)
221	TPE	UL94 HB	Ni/Cu Taffeta	Flame Retardant, Wide Variety of Profile Shapes	Profile
528	Urethane	UL94 HB	Ni/Cu Ripstop	Flame Retardant, Shear Resistant, Low Compression Set	I/O or Profile
50B	Urethane	Not Rated	Ni/Cu Ripstop	Low Cost, Shear Resistant, Low Compression Set	I/O or Profile
501	Urethane	Not Rated	Ni/Cu Taffeta	Low Cost, Low Compression Set	Profile
506	Urethane	Not Rated	Ni/Cu Knit Mesh	Low Cost, Low Compression Set	I/O

To order, contact our Sales Department.

All dimensions shown are in inches (millimeters) unless otherwise specified.





Conductive Foam

Conductive Foam offers an innovative approach to traditional shielding and grounding by providing X, Y, and Z-axis conductivity, which enhances the shielding effectiveness required to meet the increasing microprocessor speeds of today's computer, telecommunications, and aerospace equipment.

Conductive Foam is designed for low-cycling applications such as input/output (I/O) shielding and other non-shear standard connectors. Rectangular strips are available for perimeter gasketing applications.

- Halogen-free conductive foam gaskets meet 2006 European Union Directives against the use of bromide in electronic products.
- Improved Z-axis conductivity increases shielding effectiveness to over 90 dB across a wide range of frequencies.
- Available in 0.039" (1 mm), 0.060" (1.5 mm), 0.079" (2 mm), and 0.125" (3.2 mm) thicknesses and widths down to 0.125" (3.2 mm).
- Wide compression ranges of up to 60 % of original uncompressed thicknesses.
- Available in both UL94 HB and V0 rated versions.
- Available in many standard configurations including D-sub, USB port, IEEE 1394, SCSI, and RJ-45. Also available in sheet stock and rectangular profiles.
- Custom die-cut versions are also available.
- Die-cut I/O designs, Rectangle Strip gaskets and Backplane gaskets can be supplied with or without conductive or non-conductive adhesive.

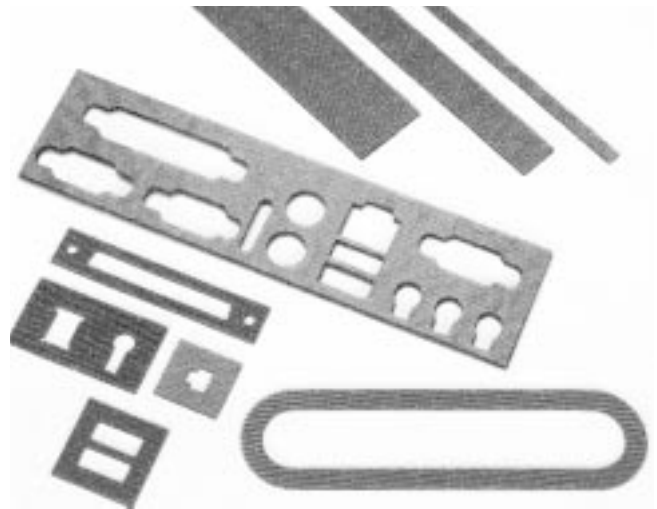

Product Performance/Physical Properties

X-Y-Axis Surface Resistivity (ASTM F390)	< 0.1 ohms/square
Z-Axis Resistivity (APM 130)	< 0.03 ohms/square
Shielding Effectiveness (Mil Std 285 Mod.)	> 90 dB (200 MHz to 10 GHz)
Abrasion Resistance (ASTM D3886)	> 1,000,000 Cycles
Compression Set (ASTM 3574)	5 % to 20 %
Service Temperature (ASTM (D746)	-40 °F to 158 °F (-40 °C to 70 °C)
Pressure Sensitive Adhesive 180 Degree Peel Strength (ASTM D3330 Mod.)	<i>Non Conductive:</i> 20 Ounces/Inch Width <i>Conductive:</i> 30 Ounces/Inch Width (Only when PSA is used)

Force Displacement Resistance Graph
 .125" (3,2 mm) Thick x 1.50 (38,1 mm) Wide
 Ni/Cu Conductive Foam Gasket

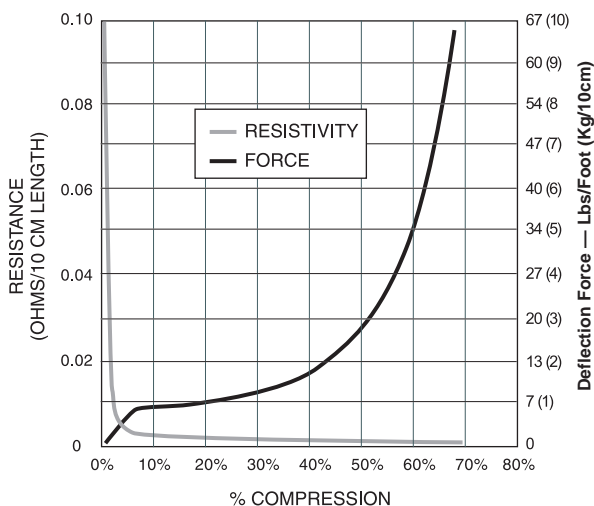

Shielding Effectiveness per MIL-STD-285 (mod.)
 Conductive Foam at 40% Compression

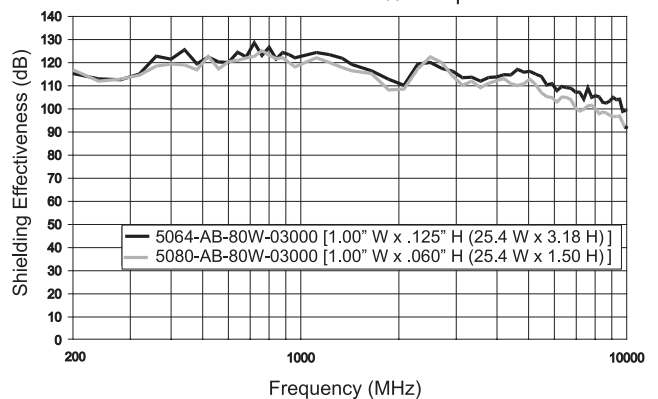

All dimensions shown are in inches (millimeters) unless otherwise specified.



Conductive Foam

Conductive Foam Gasket Tolerances

Profile	Tolerance Inches (Millimeters)
Height & Width	± .020 (0.5)
Length Inches (Millimeters)	Tolerance Inches (Millimeters)
1 to 6 (25.4 – 152.4)	± .030 (0.8)
6 to 11 (152.4 – 279.4)	± .050 (1.3)
11 to 48 (279.4 – 1219.2)	± .100 (2.5)
48 to 70 (1219.2 – 1778.0)	± .187 (4.7)
70 to 96 (1778.0 – 2438.4)	± .250 (6.4)

Pressure Sensitive Adhesive

Pressure Sensitive Adhesive	180° Peel Strength on Stainless Steel (ASTM D 3330)	Temperature Resistance (3M™ Internal Test)	Application	Thickness
Conductive	30 oz/Inch width	-40F to 158F (-40C to 70C)	I/O - Backplane Profile Gaskets	2 mils (.051)
Non-Conductive	20 oz/Inch width	-40F to 158F (-40C to 70C)	I/O - Backplane Profile Gaskets	1 mils (.025)

Other Pressure Sensitive Adhesives can be provided. Contact Engineering to discuss requirements.

Conductive Foam Construction

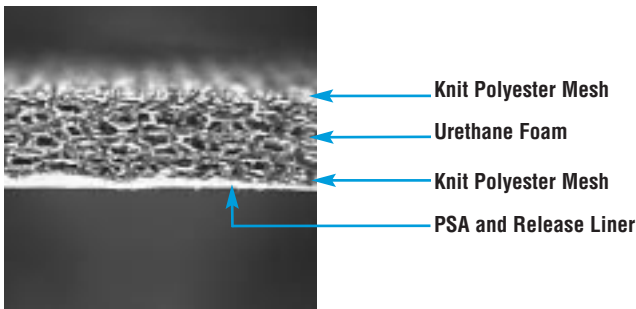

Cross Section
100% Ni/Cu Metallized

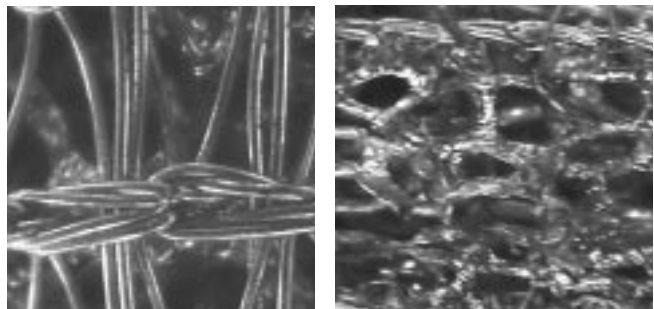

Top and Bottom Surfaces
Ni/Cu Knit Polyester Mesh

Core
Ni/Cu Metallized Urethane Foam



Conductive Foam Profile Selection Guide

Conductive foam in a rectangular profile design provides a great alternative to standard Fabric-Over-Foam profile gaskets in low shear applications. Supplied in UL94 HB or UL94 V0 fire rated material, with either conductive or non-conductive adhesive, conductive foam is a cost-effective solution for many perimeter shielding and grounding applications.

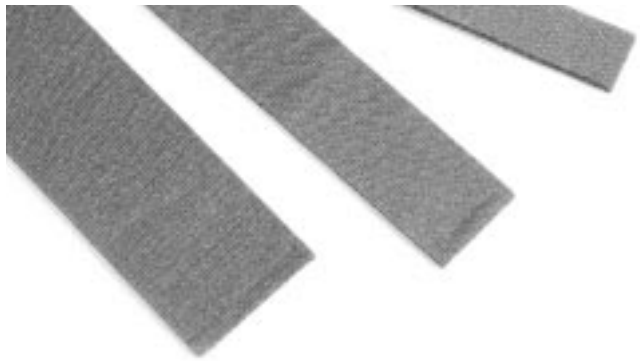

Rectangle Shaped

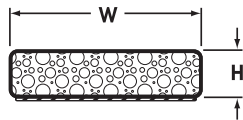

Profile Number	inches (mm) H	inches (mm) W
5286	0.040 (1.0)	1.850 (47.0)
5176	0.040 (1.0)	2.580 (65.5)
5100	0.040 (1.0)	3.350 (85.1)
5997	0.040 (1.0)	4.000 (101.6)
5308	0.060 (1.5)	0.120 (3.0)
5157	0.060 (1.5)	0.480 (12.2)
5080	0.060 (1.5)	1.000 (25.4)
5023	0.060 (1.5)	1.500 (38.1)
5076	0.060 (1.5)	1.630 (41.4)
5220	0.060 (1.5)	2.210 (56.1)
5214	0.060 (1.5)	2.410 (61.2)
5167	0.060 (1.5)	2.540 (64.5)
5168	0.060 (1.5)	2.540 (64.5)
5078	0.060 (1.5)	2.840 (72.1)

Profile Number	inches (mm) H	inches (mm) W
5092	0.060 (1.5)	3.050 (77.8)
5104	0.060 (1.5)	3.400 (86.4)
5174	0.060 (1.5)	3.600 (91.4)
5015	0.060 (1.5)	4.380 (111.2)
5191	0.060 (1.5)	4.000 (101.6)
5233	0.125 (3.2)	0.200 (5.0)
5125	0.125 (3.2)	0.390 (9.9)
5064	0.125 (3.2)	1.000 (25.4)
5219	0.125 (3.2)	1.500 (38.1)
5169	0.125 (3.2)	2.000 (51.0)
5221	0.125 (3.2)	2.210 (56.1)
5262	0.250 (6.4)	4.150 (105.4)
5261	0.250 (6.4)	2.250 (57.2)

All dimensions shown are in inches (millimeters) unless otherwise specified.



Conductive Foam I/O Gaskets Selection Guide

For shielding and grounding, conductive foam is an excellent material for Input/Output (I/O) applications. Conductive foam has excellent X, Y, and Z-axis conductivity and shielding effectiveness over 90 dB for a wide range of frequencies. Laird Technologies can help design custom gaskets to your specification using a sketch, electronic drawing or your actual equipment.

Shown here are some examples of I/O gaskets designed for specific applications.

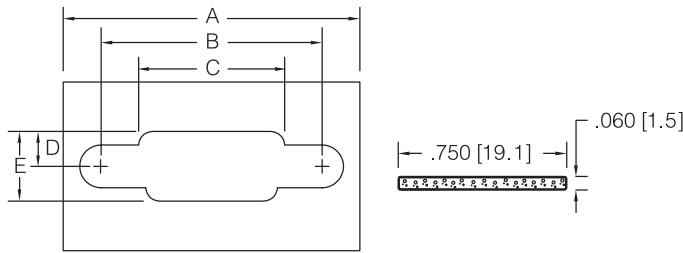

D-Sub Connector Series

Part No.	#Pins	A	B	C	D	E	Usage
5164-EE	9	1.320 (33.5)	.984 (25.0)	.650 (16.5)	.155 (4.0)	.310 (8.0)	Serial, Mouse, Com, Port
5164-EA	25	2.204 (56.0)	1.865 (47.4)	1.500 (38.1)	.155 (3.9)	.310 (7.9)	Parallel, Serial, Scanner, Printers
5164-EF	37	2.859 (72.6)	2.535 (64.4)	2.200 (55.9)	.220 (5.6)	.310 (7.9)	Serial Port

USB Port 4 Pin Connector, Part Number 5068-EA

Usage: Multi-use, hot plug-and-play

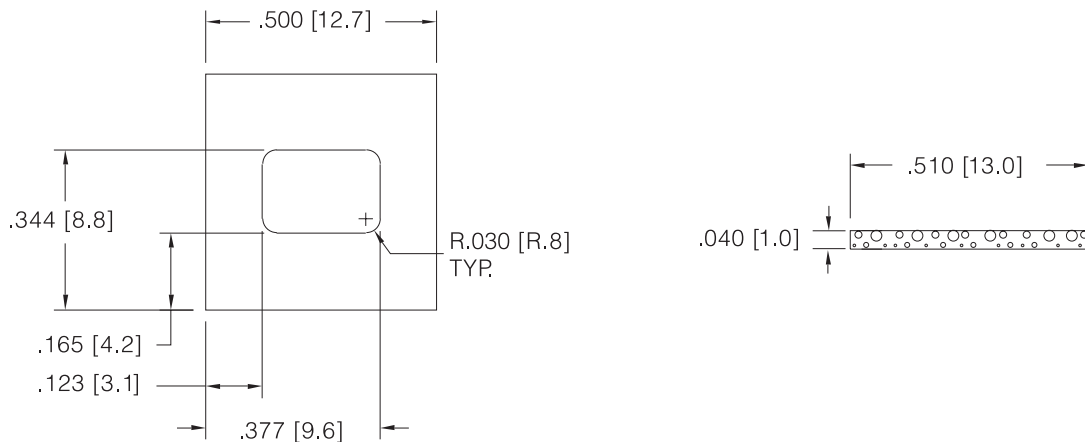

All dimensions shown are in inches (millimeters) unless otherwise specified.



USB Port Connector, Part Number 5037-EB

Usage: Peripheral Port

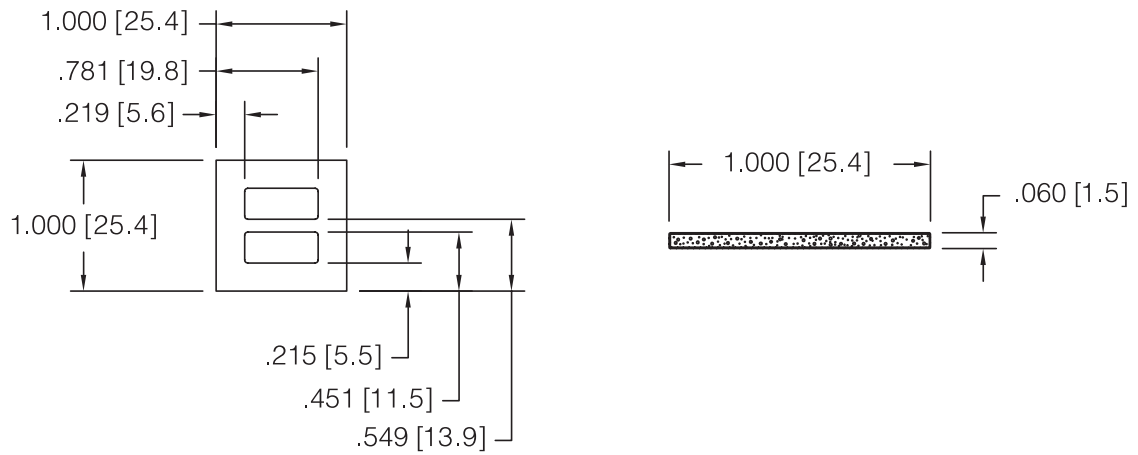

I/O Connector, Part Number 5239-EG

Usage: Standard PC Motherboard/Main Board (MB) I/O Shield

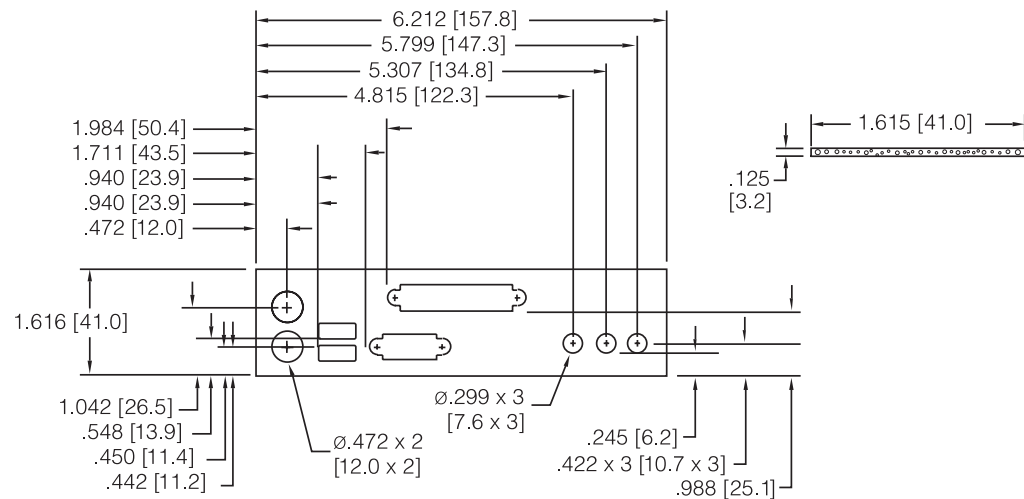

LT_KA_2003_01_MCP_E_15M · ©2003 Laird Technologies

All dimensions shown are in inches (millimeters) unless otherwise specified.



Backplanes – Large Conductive Foam Gaskets Selection Guide

Conductive foam is a perfect material for any size server, router, or switch system. For example, die-cut solutions can be provided at any length by 54" (1370 mm) wide. As with standard I/O gaskets, Laird Technologies can help design a gasket that fits your application.

Backplane Profile

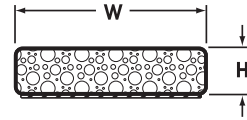

Profile Number	inches (mm) H	inches (mm) W
5010	0.060 (1.5)	6.000 (152.4)
5241	0.060 (1.5)	5.250 (133.4)
5248	0.060 (1.5)	5.630 (143.0)
5269	0.060 (1.5)	5.880 (149.4)
5264	0.060 (1.5)	7.870 (200.0)
5152	0.060 (1.5)	25.500 (647.7)
5044	0.125 (3.2)	6.150 (156.2)
5151	0.125 (3.2)	6.500 (165.1)
5213	0.125 (3.2)	5.820 (147.8)
5249	0.125 (3.2)	6.490 (164.8)
5268	0.125 (3.2)	6.750 (171.5)
5999	0.125 (3.2)	14.000 (355.6)
5242	0.185 (4.7)	6.000 (152.4)

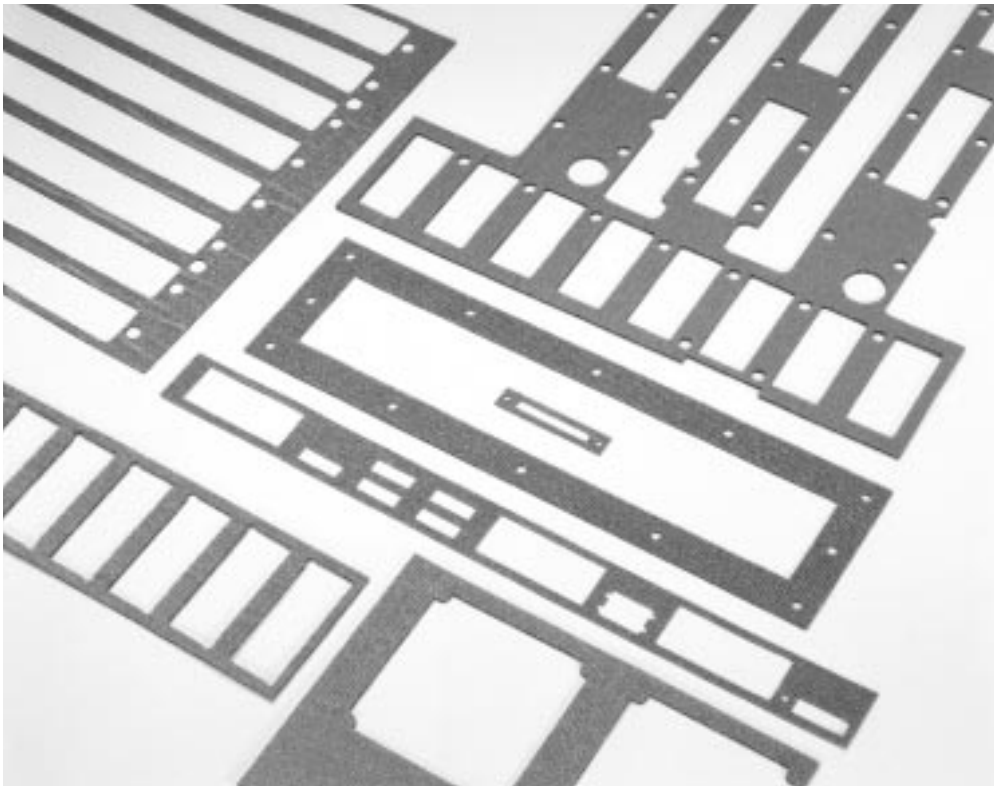

Examples of Large Backplane Gaskets



Conductive Foam Profile and I/O Gaskets Ordering Information

Part Number Example:

Digits: 1 2 3 4 5 6 7 8 9 10 11 12 13 14
5 2 3 9 - X X - 8 2W - 0 2 6 0 0

Digit 1: Product Type

Designates conductive foam (5).

Digits 2 through 4: Drawing Number for Basic Profile

Designate the part shape and size. (i.e., In the above example, the "239" indicates a 0.125" (3.2 mm) high by 1.615" (41.0 mm) wide flat stock gasket.) These digits will be defined and supplied by Laird Technologies Engineering personnel.

Digits 5 through 6: General Guidelines of Customized Options

Designate part-specific attributes of the product including cutouts, notches, tape width, tape position and a variety of other customized details. These digits will be defined and supplied by Laird Technologies Engineering personnel.

Digit 7: Core Material

Designates the core material Nickel/Copper (Ni/Cu) foam (8).

Digit 8: Flammability Rating

Designates the fire rating: (1) - UL94 V0
(2) - UL94 HB

Digit 9: Cover Fabric

Designates the outer covering
W = Ni/Cu Mesh with PSA
X = Ni/Cu Mesh

Digits 10 through 14: Specific Cut Lengths

Designates the part length in inches to two decimal places. (i.e., In the above example, the "02600" denotes a 26.00 inch (660.40 mm) long gasket.) For reeled gasket material, it designates the reel length in feet to two decimal places.



Construction Options

Part Number Suffix (Digits 7,8,9)	Metallized Fabric Type	Core Material	UL94 Fire Rating	General Benefits	Target Application
81W	Ni/Cu Mesh with PSA	Ni/Cu Foam	UL94 V0	Flame Retardant, Low Compression Set, Adhesive	Profile, I/O, Sheet or Backplane
82W	Ni/Cu Mesh with PSA	Ni/Cu Foam	UL94 HB	Flame Retardant, Low Compression Set, Adhesive	Profile, I/O, Sheet or Backplane
81X	Ni/Cu Mesh	Ni/Cu Foam	UL94 V0	Flame Retardant, Low Compression Set	Profile, I/O, Sheet or Backplane
82X	Ni/Cu Mesh	Ni/Cu Foam	UL94 HB	Flame Retardant, Low Compression Set	Profile, I/O, Sheet or Backplane

To order, contact our Sales Department.

All dimensions shown are in inches (millimeters) unless otherwise specified.



Conductive Fabric

Electron® metallized fabric combines highly conductive metals with lightweight fabric to meet a diverse range of EMI/RFI shielding requirements. Manufactured with Laird Technologies' patented technology, Electron metallized fabric is available in various woven and non-woven substrate configurations. Whether used as an architectural shielding product to shield complete rooms, or as the shielding material in EMI gaskets, tapes, and shield laminates, Electron fabrics provide a highly effective shielding system that is cost-effective and easily applied.

Laird Technologies uses a patented technology for applying thin metal coatings of copper or nickel to woven and nonwoven fabrics. As a result, Electron metallized materials have the flexibility, conformability and breathability of a fabric with the electrical properties of a metal. Because the manufacturing process does not use an electric potential, the fabric receives a uniform coating of metal on the individual fibers and excellent plating at the fiber crossover points. This means low surface and through resistivity and excellent shielding effectiveness.

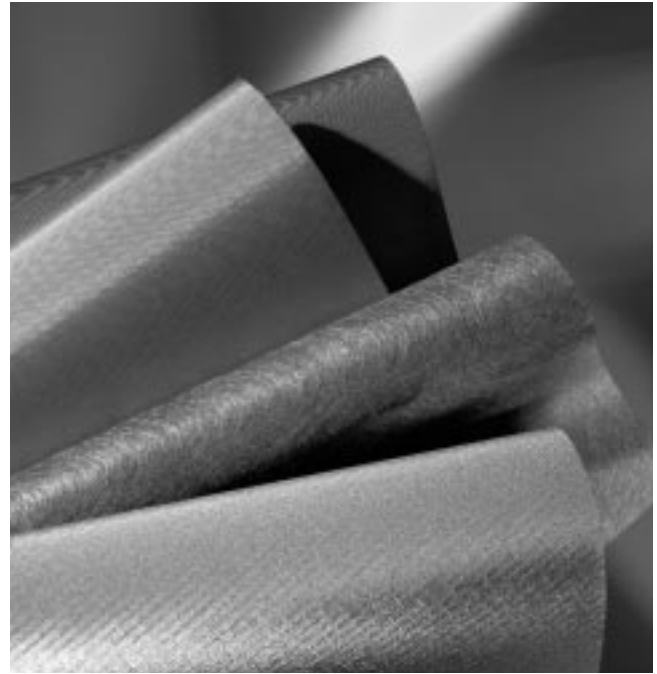

Electron® Products Data Summary

	Product No.	Nominal Thickness Inches (mm)	Surface Resistivity ¹ (Ohms/square) (ASTM F390)	Shielding ² at 100 MHz/1GHz (dB) (Mil-Std 285)	Tensile Strength ³ CD/MD ⁴ (lb/in)	Air Flow ³ (ft ³ /min/ft ²)	Weight (oz/yd ²) (LT 500)	Max. Short Duration Temperature (°C)
Cu Polyester Nonwoven	3027-106	0.016 (0.4)	≤ 0.1	80/100	7.5/18.5	690	1.5 – 2.3	210
Ni/Cu Polyester Nonwoven	3027-217	0.016 (0.4)	≤ 0.07	100/100	7.5/18.5	690	1.8 – 3.0	210
Ni/Cu Polyester Nonwoven UL94 VTM-0	3027-235	0.016 (0.4)	≤ 0.07	100/100	7.5/18.5	690	13 [†]	210
Ni/Cu Polyester Taffeta	3035-213*	0.006 (0.2)	≤ 0.07	80/70	50/75	66	2.2 – 3.3	210
Ni/Cu Polyester Taffeta UL94 V0	3035-216*	0.008 (0.2)	≤ 0.07	80/70	19/81	NA	7.0 – 9.0	100
Ni/Cu Polyester Ripstop	3055-233*	0.007 (0.2)	≤ 0.07	90/80	60/65	68	2.2 – 3.3	210
Ni/Cu Polyester Mesh	3070-500	0.008 (0.2)	≤ 0.07	53/48	64/24	NA	1.3 – 2.3	210
Cu Nylon Ripstop	3050-113	0.005 (0.1)	≤ 0.1	70/70	52/56	97	1.4 – 1.9	200
Ni/Cu Nylon Ripstop	3050-226*	0.005 (0.1)	≤ 0.07	70/70	52/56	97	1.4 – 1.9	200
Ni/Cu Nylon Ripstop UL94 V0	3050-517*	0.008 (0.2)	≤ 0.07	85/75	52/56	NA	5.5 – 7.0	100
Cu Polyester Ripstop	3055-121	0.007 (0.2)	≤ 0.1	90/80	60/65	68	2.0 – 2.7	210

NA = Not Applicable

¹ Product Specifications

² Measured per MIL STD 285, Typical values

³ Typical values for unplated fabric.

⁴ CD = cross machine direction, MD = machine direction

[†] Nominal Value

* Note: Optional anti-fray coating on Ni/Cu woven material.

All dimensions shown are in inches (millimeters) unless otherwise specified.



Conductive Fabric Descriptions and Applications

For specific material properties, see Data Summary Chart (page 25)

Product No.	Material	Description	Application
3027-106	Cu Polyester Nonwoven	Combines a highly conductive metal with the light weight, flexibility, and breathability of a nonwoven. Offers excellent surface conductivity, shielding effectiveness, and reflectivity.	Protects against EMI/RFI and ESD where weatherability is not a concern: architectural gaskets, tapes, shielding laminates, and grounding.
3027-217	Ni/Cu Polyester Nonwoven	The base layer is the highly conductive copper, with an outer layer of nickel for corrosion resistance. Combines the properties of these metals with the light weight, flexibility and breathability of a nonwoven material. Offers excellent surface conductivity, shielding effectiveness, and corrosion resistance.	Protects against EMI/RFI and ESD for a variety of applications and environments: architectural shielding, gaskets, tapes, shielding materials and ribbon.
3027-235	Ni/Cu Polyester Nonwoven UL94 VTM-0	Combines highly conductive copper and corrosion resistant nickel with the lightweight, flexibility and breathability of a nonwoven. Offers excellent surface conductivity, shielding effectiveness and corrosion resistance. This product achieves the UL94 VTM-0 flammability rating.	Protects against EMI/RFI and ESD for a variety of applications and environments: architectural shielding, gaskets, tapes, shielding laminates, and grounding.
3035-213*	Ni/Cu Polyester Taffeta	Combines highly conductive copper and corrosion resistant nickel with the light weight, flexibility, conformability, strength and uniform appearance of a woven. Nickel/Copper Polyester Taffeta offers excellent surface conductivity, shielding effectiveness, and reflectivity.	Protects against EMI/RFI for a variety of applications and environments: enclosures, curtains, gaskets, cable wrap, tapes, shielding laminates, and grounding.
3035-216*	Ni/Cu Polyester Taffeta UL94 V0	Combines highly conductive copper and corrosion resistant nickel with the light weight, flexibility, conformability, strength and uniform appearance of a woven. Nickel/Copper Polyester Taffeta offers excellent surface conductivity shielding effectiveness, and reflectivity.	Protects against EMI/RFI for a variety of applications and environments: enclosures, curtains, gaskets, cable wrap, tapes, shielding laminates, and grounding.
3055-233*	Ni/Cu Polyester Ripstop	The base layer is the highly conductive copper, with an outer layer of nickel for corrosion resistance. Combines the properties of these metals with the light weight, drapability, strength, and attractive appearance of a Polyester Ripstop. Nickel/Copper Polyester Ripstop offers excellent surface conductivity, shielding effectiveness, and corrosion resistance.	Protects against EMI/RFI and ESD for a variety of applications and environments: enclosures, cables, gaskets, tapes, and grounding.
3070-500	Ni/Cu Polyester Mesh	Combines highly conductive copper and corrosion resistant nickel with the light weight, flexibility, conformability, breathability and uniform appearance of a knitted mesh. Mesh offers excellent surface conductivity, shielding effectiveness, and reflectivity for a variety of applications.	Protects against EMI/RFI for a variety of applications and environments: enclosures, curtains, gaskets, cable wrap, tapes, shielding laminates, and grounding.
3050-113	Cu Nylon Ripstop	This technology combines a highly conductive metal with the light weight, drapability, strength, flexibility, conformability, and attractive appearance of a nylon ripstop. Copper Nylon Ripstop offers excellent surface conductivity, shielding effectiveness, and reflectivity.	Protects against EMI/RFI where weatherability is not a concern: enclosures, curtains, tapes, shielded laminates, infrared camouflage, and radar reflector.
3050-226*	Ni/Cu Nylon Ripstop	This technology combines highly conductive copper and corrosion resistant nickel with the lightweight, drapability, strength, flexibility, conformability, and attractive appearance of a Nylon Ripstop. Nickel/Copper Nylon Ripstop offers excellent surface conductivity, shielding effectiveness, and reflectivity.	Protects against EMI/RFI: enclosures, curtains, gaskets, tapes, shielded laminates, infrared camouflage, and radar reflector.
3050-517*	Ni/Cu Nylon Ripstop UL94 V0	This technology combines highly conductive copper and corrosive resistant nickel with the drapability, strength, flexibility, and attractive appearance of a Nylon Ripstop fabric. Excellent surface conductivity, shielding effectiveness, and UL94 V0 rating.	Protects against EMI/RFI: enclosures, cables, tapes, and grounding.
3055-121	Cu Polyester Ripstop	This technology combines a highly conductive metal with the lightweight drapability and attractive appearance of a Polyester Ripstop. Copper Polyester Ripstop offers excellent surface conductivity and shielding effectiveness.	Protects against EMI/RFI and ESD: enclosures, cables, tapes, grounding, infrared camouflage, and radar reflector.

* Note: Optional anti-fray coating on Ni/Cu woven material.

All dimensions shown are in inches (millimeters) unless otherwise specified.





Conductive Tape

Conductive ElectroTape

A soft conductive foil is laminated to a conductive acrylic adhesive which is protected by a siliconised paper cover. The foils can either be supplied with bright surface or with tin plating. Beside the standard widths other dimensions per customer specification are possible. In this case there is a min. quantity of reels which is determined by the master reel with a width of 11,811 inch (300 mm) out of which the individual reels have to be cut.

Also available:

With conductive acrylic adhesive on both sides.



Part No.	8271-xxxx-39	8271-xxxx-76	8277-xxxx-77	8277-xxxx-39	8277-xxxx-76
Foil material	soft copper	soft copper	soft aluminium	soft copper	soft copper
Surface	bright + clean	tin plated	bright + clean	bright + clean	tin plated
Thickness foil material	0,001 (0,035)	0,001 (0,035)	0,002 (0,040)	0,001 (0,035)	0,001 (0,035)
Thickness incl. Adhesive	0,002 (0,065)	0,002 (0,065)	0,003 (0,070)	0,003 (0,085)	0,003 (0,085)
Adhesive	electrically conductive acrylic	electrically conductive acrylic	electrically conductive acrylic	electrically conductive acrylic	electrically conductive acrylic
Protective cover over foil material	no	no	no	not applicable	not applicable
Adhesive performance	4,5 N/cm	4,5 N/cm	4,5 N/cm	5 N/cm	5 N/cm
Tensile strength	50 N/cm	40 N/cm	25 N/cm	55 N/cm	40 N/cm
Tear elongation	6 - 10%	5%	8%	-	5%
Max. temp. contin.	+ 150°C	+ 150°C	+ 150°C	+ 150°C	+ 150°C
Width of foil in mm	12-20-25	12-20-25	12-20-25	12-20-25	12-20-25
Length/reel in m	33	33	33	33	33
Resistance along foil	0,002 Ω	0,002 Ω	<1 Ω	not applicable	not applicable
Resistance through foil	<0,1 Ω	<0,1 Ω	<1 Ω	<0,1 Ω	<0,1 Ω
Listing per	MIL-T-47012	-	MIL-T-47012	-	-
Construction	Foil 1	Foil 1	Foil 1	Foil 2	Foil 2

Foil 1



Foil 2

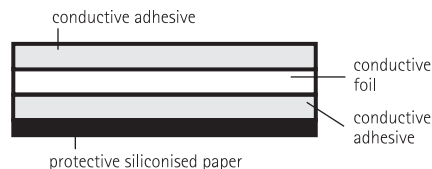

Ordering Code

The ordering code consists of the partgroups, reel width and material code:

8271-0020-76



material code
reel width
partgroups

For length and widths not shown, design assistance, samples, or further information, contact our sales department.

All dimensions shown are in inches (millimeters) unless otherwise specified.



Conductive Tape

Conductive ElectroMask Tape

ElectroMask conductive foil tape with release mask is a tinned copper tape with peel off mask that allows for high temperature adhesion to withstand curing after painting.

The tape provides a conductive, non-corroding surface when applied to clean metal frames, doors, or panel surfaces where electrical conductivity is required. The release mask is easily removed from the foil layer after painting. The remaining foil leaves a clean, electrically conductive path as a mating surface for an EMI gasket.

- Simple installation.
- Eliminates plating the entire cabinet.
- Die-cut shapes can be provided for grounding points within the closure.

ElectroMask Tape with release mask is offered in continuous rolls of 108 feet (32,92 m), or custom die-cut shapes.

Application Instructions For Release Mask Tape

1. Conductive surface must be clean and free of any residue. If required, re-new mounting surface with light emery cloth or proper solvent.
2. Apply release mask tape by removing protective paper backing. Press firmly and uniformly to ensure

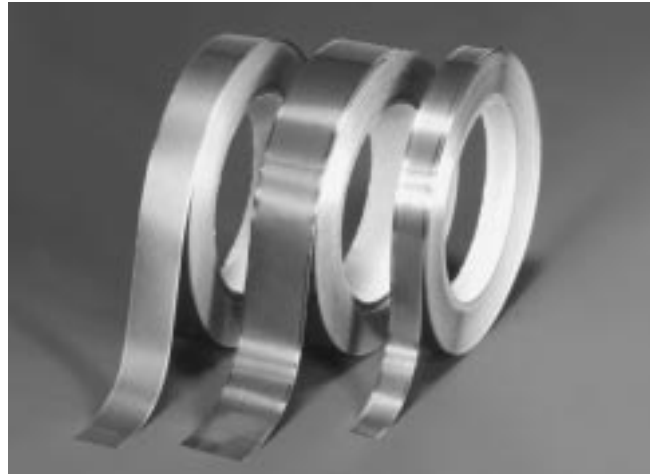

good adhesion. Proper alignment is important. Avoid removal and repositioning. Allow one hour for bonding prior to additional processing.

3. Use traditional methods to apply paint to masked area. Release mask tape will withstand baking temperatures up to 437 °F (225 °C) up to 60 minutes.
4. Remove mask as soon as the enclosure cools to room temperature by peeling backward, parallel to foil tape. If foil separates from the surface, simply press back in place.
5. Full adhesion is achieved after 24 hours.



Example of application

1) Apply copper band to the contact surface

2) Painting

3) Drying the colour

4) Remove protective foil: Contact surface is free

Ordering Code

The ordering code consists of the partgroups, reel width and material code:

8274-0020-76

material code
reel width
partgroups

Part No.	8274-xxxx-39	8274-xxxx-76
Foil material	soft copper	soft copper
Surface	bright + clean	tin plated
Thickness foil material	0,001 (0,035)	0,001 (0,035)
Thickness incl. Adhesive	0,002 (0,065)	0,002 (0,065)
Adhesive	electrically conductive acrylic	electrically conductive acrylic
Protective cover over foil material	Polyester shrink foil	Polyester shrink foil
Adhesive performance	4,5 N/cm	4,5 N/cm
Tensile strength	50 N/cm	40 N/cm
Tear elongation	6 - 10%	5%
Max. temp. contin.	+ 150°C	+ 150°C
Width of foil in mm	12-20-25	12-20-25
Length/reel in m	50	50
Resistance along foil	0,002 Ω	0,002 Ω
Resistance through foil	<0,1 Ω	<0,1 Ω
Listing per	MIL-T-47012	-

All dimensions shown are in inches (millimeters) unless otherwise specified.



High-Flex® Conductive Fabric Shielding Tape

High-Flex® conductive fabric shielding tapes offer exceptional conformability and conductivity for dynamic flex applications. High-Flex® tapes are constructed of Electron® nickel/copper metallized ripstop or plain weave fabric with a pressure sensitive adhesive (PSA). This reliable tape design provides outstanding shielding performance while offering superior abrasion and corrosion resistance under high dynamic flex conditions.

The proprietary anti-fray coating of High-Flex® EMI shielding tapes virtually eliminates concerns of loose conductive fibers and their potential to cause board level damage. Other significant advantages over other fabric and foil shielding tapes include:

- Thinner design provides superior flexibility and durability.
- High conductivity and shielding effectiveness.
- Adhesive system provides high peel strength.
- Easy die-cutting and processing.
- Superb adhesion of nickel copper plating.
- Eliminates the potential of injury due to the sharp edges of metal foil tapes.

High-Flex® EMI shielding tape is available in standard roll widths from 0.394" (10 mm) to 1.969" (50 mm) in 0.197" (5 mm) increments and roll lengths of 65.62' (20 M). Master rolls are available in sizes up to 1.4 meter widths and 300 meter lengths. For your unique design requirements, custom die-cut parts are also available.

Some typical applications for High-Flex® EMI shielding tapes include:

- Shielding cables on notebook computers, copiers or other electronic equipment.
- "Fix-it" applications in test laboratories.
- Shielding over a component in which high conformability is essential.
- Shielding or grounding in weight sensitive applications.
- Shielding or grounding for electronic equipment where vibration may be present during operation.

Tape Construction

Carrier	Electron® Nickel Copper Ripstop Fabric (1A) Electron® Nickel Copper Ripstop Fabric (2T) Electron® Metallized Nickel Copper Plain Weave Fabric (2Z)
Adhesive	High Strength Pressure Sensitive Acrylic Adhesive
Liner	Kraft Paper

Performance Characteristics

	High-Flex® Tape 1A = Nickel Copper Ripstop Fabric	High-Flex II® Tape 2T = Nickel Copper Ripstop Fabric 2Z = Nickel Copper Plain Weave Fabric
Tape Thickness	0.004 to 0.005 inches (0.10 mm to 0.13 mm)	0.003 to 0.005 inches (0.08 mm to 0.13 mm)
Liner Thickness	0.005 to 0.006 inches (0.13 mm to 0.15 mm)	0.003 to 0.004 inches (0.08 mm to 0.10 mm)
Break Strength (ASTM 5035)	50 lb./in. (856/100 mm)	50 lb./in. (856/100 mm)
Weight (LT 500)	2.3 to 3.0 oz./sq. yard (78.0 to 118.7 grams/sq. Meter)	2.3 to 3.0 oz./sq. yard (78.0 to 118.7 grams/sq. Meter)
XY Sheet Resistivity (ASTM F390)	Below 0.08 ohms/sq. (Typically 0.03 ohms/sq.)	Below 0.05 ohms/sq. (Typically 0.02 ohms/sq.)
Peel Strength (ASTM D330 & PSTC-1)	48 oz./in. (52 N/100 mm)	54 oz./in. (59 N/100 mm)
Abrasion Resistance (ASTM D3886)	> 1,000,000 Cycles	> 1,000,000 Cycles
Temperature Range	-40 °F to 212 °F (Min/Max) (-40 °C to 100 °C)	-40 °F to 212 °F (Min/Max) (-40 °C to 100 °C)
Shielding Effectiveness per Mil-Std-285 (Mod.)	> 70 dB up to 18GHz	> 70 dB up to 18GHz

All dimensions shown are in inches (millimeters) unless otherwise specified.



Ordering Information:

Digits: 1 2 3 4 5 6 7 8 9 10 11
1 A 0 2 5 0 R 0 2 0 0

Digits 1 and 2

Designate conductive tape product line and fabric options: 1A = Nickel Copper Ripstop Fabric
2T = Nickel Copper Ripstop Fabric
2Z = Nickel Copper Plain Weave Fabric

Digits 3 through 6

Designate width in millimeters to one decimal place. (i.e., in the above example, the 0250 indicates a 25 mm wide roll).

Digit 7

Designates the form the tape is provided in: R = Roll K = Kiss-Cut in Pieces P = Pieces

Digits 8 through 11

Designate the roll length in meters to one decimal place (i.e., in the above example 0200 indicates a roll length of 20 meters).

Shielding Effectiveness

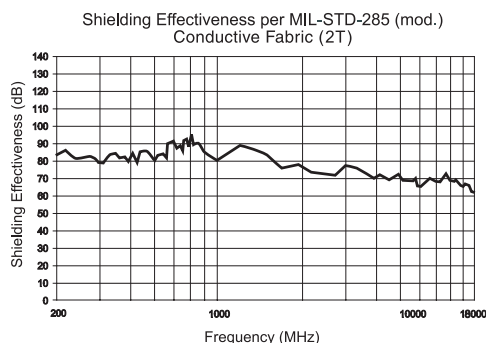



Notes



Effective shielding solutions for a great variety of applications

European Locations

Germany

Laird Technologies GmbH
Äußere Oberastraße 22
83026 Rosenheim, Germany
Phone +49 (0) 80 31/24 60 0
Fax +49 (0) 80 31/24 60 50
europe@lairdtech.com



UK

Laird Technologies Ltd.
Warner Drive
Springwood Industrial Estate
Braintree
Essex CM7 2YW
Phone +44 (0) 13 76/34 26 26
Fax +44 (0) 13 76/34 64 42
europe@lairdtech.com



France

Laird Technologies SAS
13 -15 rue des Entrepreneurs
91560 Crosne, France
Phone +33 (0) 1 69/49 79 79
Fax +33 (0) 1 69/49 79 80
europe@lairdtech.com



Czech Republic

Laird Technologies s. r. o.
Průmyslová 497
46211 Liberec
Phone +420 4 88/57 51 11
Fax +420 4 88/57 53 03
europe@lairdtech.com



www.lairdtech.com

